

# Installation & Servicing Instructions

XL70  
XL110  
XL140

**ATAG**



These instructions are to be retained by the user.

Version:  
from sv 4.1  
05-2013

# Content

1	Introduction.....	4
2	Regulations .....	7
3	Scope of delivery.....	9
4	Description .....	10
5	Installation and mounting .....	11
5.1	Wall-mounted in line .....	12
5.2	Free-standing in line.....	13
5.3	Free-standing back to back.....	14
5.4	Connecting the boiler .....	15
6	Hydraulic and gas line system.....	16
6.1	Heating system .....	16
6.2	Expansion vessel .....	17
6.3	Water quality .....	17
6.4	Gas line .....	19
6.5	Condensate drain.....	20
6.6	Hot water supply .....	22
7	Flue gas system .....	23
7.1	Parallel boiler connection .....	24
7.2	Concentric boiler connection.....	24
7.3	Connecting the flue gas outlet/air supply system.....	25
7.4	Individual flue gas outlet.....	25
7.5	Collective flue gas outlet .....	28
7.6	Condensate vent collective flue gas system .....	31
8	Electrical connections.....	32
8.1	External controls .....	34
8.2	Wiring diagram .....	36
9	Boiler control .....	38
9.1	Operational status .....	39
9.2	Operation .....	39
9.3	Commissioning.....	40
9.4	Filling heating system.....	43
10	Basic settings .....	45
11	Parameters .....	47
11.1	Activate factory settings .....	50
12	Put out of operation .....	50
13	Inspection and maintenance .....	51
13.1	Maintenance intervals .....	51
13.2	Checks prior to commissioning .....	51
13.2.1	Pollution check.....	52
13.2.2	Control O <sub>2</sub> .....	53
13.3	Maintenance activities.....	54
13.4	Counter running hours .....	57
13.5	Warranty.....	57
14	Error report .....	58
	Annex A Technical specifications.....	59
	Annex B System water additives .....	60
	Annex C Dimensions .....	61
	Annex D Resistance table sensors.....	66
	Annex E Declaration of conformity .....	67
	Annex Benchmark commissioning checklist and service record .....	68

# 1 Introduction

These instructions describe the functioning, installation, use and primary maintenance of ATAG central heating boilers for the United Kingdom and Ireland. Where necessary the different regulations for each country are separately described.

These instructions are intended for the use of Gas Safe registered installers or registered Bord Gais installers in connection with the installation and putting into operation of ATAG boilers. It is advisable to read these instructions thoroughly, well in advance of installation. Separate instructions for use are supplied with the boiler for users of ATAG central heating boilers. ATAG is not liable for the consequences of mistakes or shortcomings which have found their way into the installation instructions or user's manual. Further, ATAG reserves the right to alter its products without prior notification.



**When delivering the boiler, give the customer clear instructions concerning its use; present the customer with the user's manual and card.**



**With regard to installing flue systems and/or external controls, we refer you to the supplier involved.**

Each boiler is fitted with an identification plate. Consult the details on this plate to verify whether the boiler is compliant with its intended location, e.g.: gas type, power source and exhaust classification.

On completion of the installation, the installer or commissioning engineer must fill out and complete the Commercial Commissioning/Service Sheet supplied with the boiler and hand this to the customer for future record keeping. The Service Sheet must also be completed by the service agent following each service call, and returned to the customer. A copy of the Commercial Commissioning/Service Sheet must be returned to ATAG Heating along with the warranty registration card to register the appliance for the standard warranty benefits.



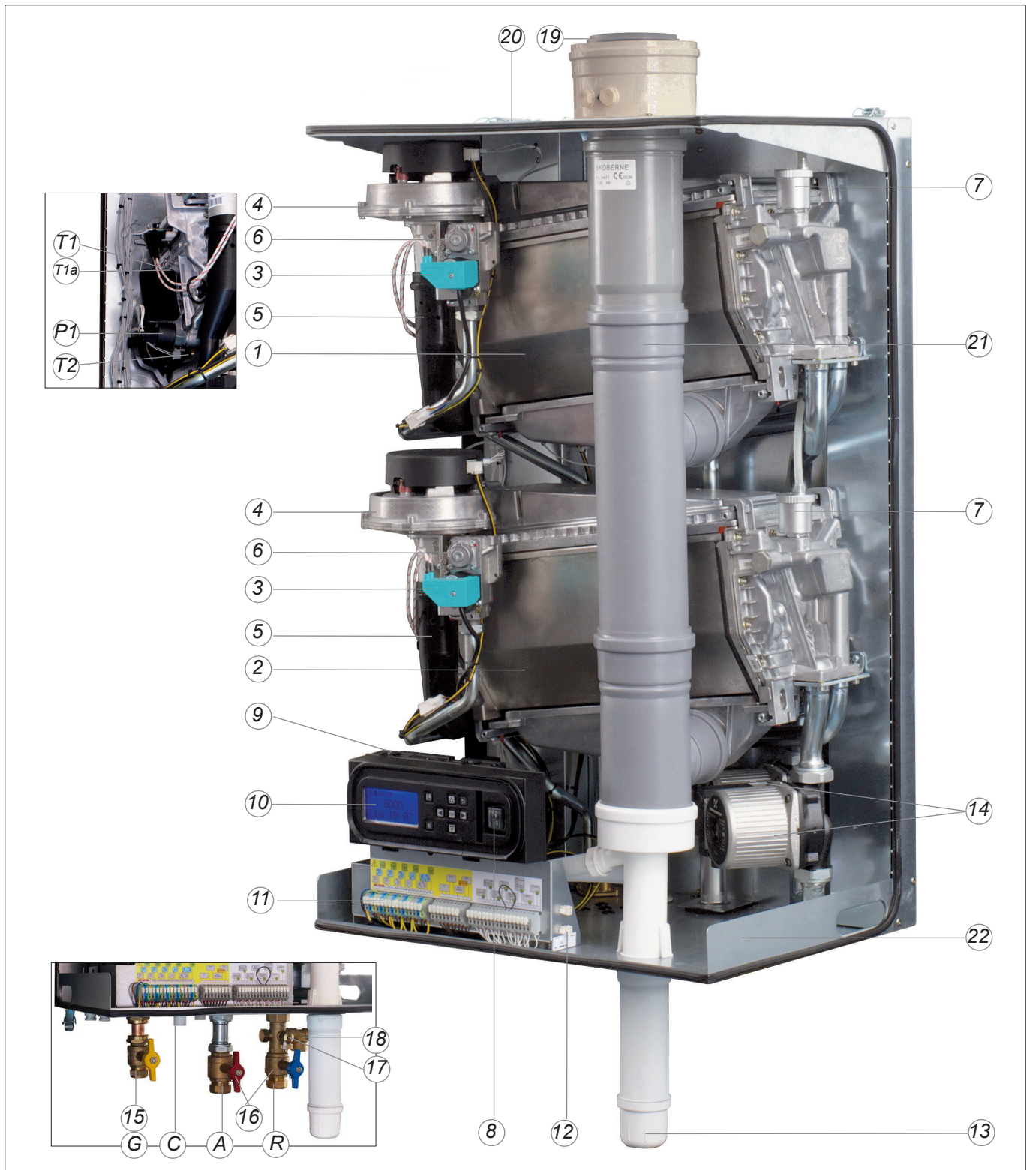
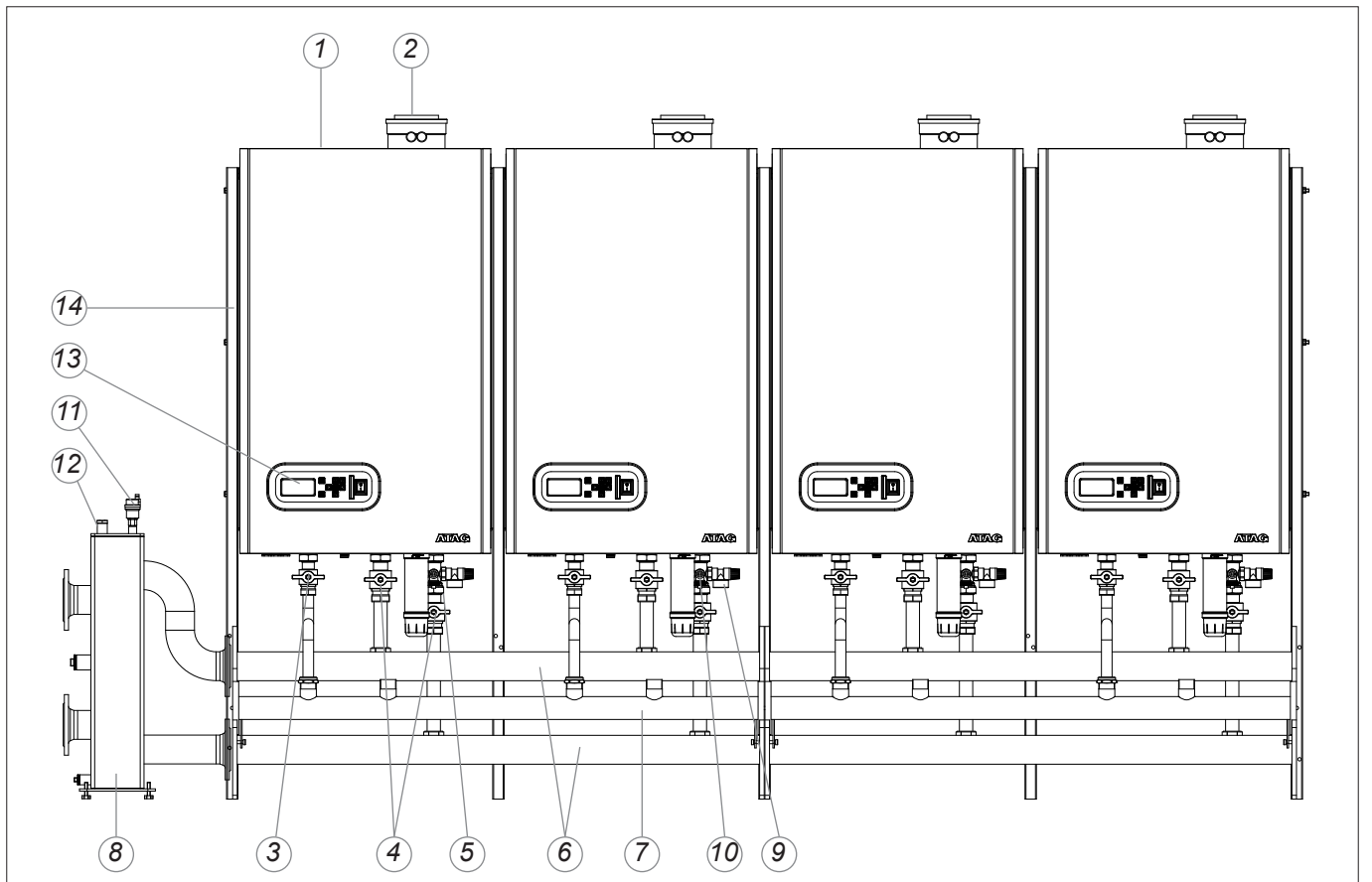

figure 1.a

description components

- |    |  |     |   |
|----|--|-----|---|
| 1  | heat exchanger 1 (All types OSS4)                        | 16  | service valves flow/return (in optional boiler connections set) |
| 2  | heat exchanger 2 (XL110: OSS2, XL140:OSS4)               | 17  | fill and drain valve (in optional boiler connections set)       |
| 3  | ignition unit  | 18  | safety valve (in optional boiler connections set)               |
| 4  | fan unit   | 19  | flue connection (concentric)                                    |
| 5  | damper   | 20  | air supply (for parallel flue connection)                       |
| 6  | gas valve  | 21  | collective flue pipe  |
| 7  | automatic air vent                                       | 22  | information plate   |
| 8  | main switch 230V   | T1  | flow sensor   |
| 9  | boiler control unit                                      | T1a | secondary flow sensor (only OSS4)                               |
| 10 | control unit MMI   | T2  | return sensor   |
| 11 | connection terminal                                      | P1  | water pressure sensor   |
| 12 | connection terminal cascade bus communication            | G   | gas pipe  |
| 13 | siphon   | A   | flow pipe CH  |
| 14 | circulation pump   | R   | return pipe CH  |
| 15 | gas isolation valve (in optional boiler connections set) | C   | condensate drain pipe   |



description components

figure 1.b

- |   |   |    |  |
|---|---|----|--|
| 1 | Air supply (for parallel flue connection) | 8  | Low velocity header                    |
| 2 | Flue/Air supply (concentric)              | 9  | Safety valve 4 bar                     |
| 3 | Gas isolation valve                       | 10 | Fill and drain valve                   |
| 4 | Service valves flow and return            | 11 | Automatic air vent low velocity header |
| 5 | Non-return valve                          | 12 | Pocket for temperature sensor T10      |
| 6 | Flow/return header                        | 13 | Cascade manager                        |
| 7 | Gas line                                  | 14 | Frame                                  |

The following regulations apply to the installation of ATAG central heating boilers:

Legislation and Regulations.

Gas Safety (Installation and Use) Regulations. All gas appliances must by law, be installed by a competent person, eg. Members of Gas Safe Register and in accordance with the current Gas Safety (Installation and Use) Regulations. Failure to install the appliance correctly could lead to prosecution.

All Gas Safe registered installers carry a Gas Safe ID card and have a registration number. You can call Gas Safe Register directly on 0800 408 5577.

In addition to the above regulations this appliance must be installed in compliance with the current IEE Regulations, the Building Standards (Scotland Consolidation) Regulations. Regulations and byelaws of the Local Water Authority and the Current Health and Safety Regulation.

Installers are required to carry out installation, commissioning and servicing work in accordance with the Benchmark Code of Practice which is available from the Heating and Hot water Industry Council who manage and promote the Scheme.

Visit [www.centralheating.co.uk](http://www.centralheating.co.uk) for more information.

### Ireland:

- Irish standard 813

The current Electricity at Work Regulation must be complied with and also be in accordance with the relevant and current editions of the British Standards.

The ATAG XL boiler is a certified appliance and must not be modified or installed in any way contrary to this Installation Manual. Manufacturers instructions must not be taken, in any way, as overriding statutory obligations.

The ATAG XL is a central heating boiler for individual or multiple cascade purposes. These boilers must be connected according to these instructions and all installation norms in respect of the part of the boiler to be connected.



**The device may be operated only by authorized persons who have been instructed on the operation and use of the device. Improper use may cause damage to the device and / or to the connected installation.**



**The appliance is not to be used by children or persons with reduced physical, sensory or mental capabilities, or lack of experience and knowledge, unless they have been given supervision or instructions.**



**Children being supervised are not to play with the appliance.**

Observe the following rules of safety:

- All work on the boiler must take place in a dry environment.
- ATAG boilers may never be in operation without their housing, except in connection with maintenance or adjustments (see Chapter 13).
- Never allow electrical or electronic components to come into contact with water.

Carry out the following tasks in connection with maintenance, etc. to an already-installed boiler:

- Shut down all programs
- Close the gas isolation valve
- Turn off the boilers electrical isolator switch.

Take note of the following when maintenance or adjustments are needed:

- The boiler must be able to function during these activities; for this reason, the boiler's supply voltage, gas pressure and water pressure must be maintained. Ensure that there is not a source of potential danger during these activities.



**Following maintenance or other activities; always check the connections of all parts through which gas flows using leak detection fluid (LDF).**

The following (safety) symbols may be encountered in these installation instructions and on the boiler:



**This symbol indicates that the boiler must be stored away from frost.**



**This symbol indicates that the packaging and/or contents can be damaged as a result of insufficient care taken during transport.**



**This symbol indicates that, whilst still in its packaging, the boiler must be protected from weather conditions during transport and storage.**



**KEY-symbol. This symbol indicates that assembly or dismantling, must be carried out.**



**ATTENTION symbol. This symbol indicates that extra attention must be paid in connection with a particular operation.**



**Useful tip or advice.**

### 3 Scope of delivery

The boiler will be delivered ready for use. The delivery package includes the following:

- Boiler and housing:
  - Boiler pump(s);
  - Cascade control system;
  - Automatic air vent(s);
- Siphon;
- Lid  $\varnothing$ 100 air supply (with screw);
- PG cable glands;
- Suspension bracket;
- Mounting material consisting of plugs and screws;
- Installation manual;
- Instruction manual;
- Warranty card.

Depending on the selected cascade systems, the following parts are supplied:

1. Pipe work headers for flow/return and gas
  - DN65 or DN100 flow/return pipe work headers for 2 or 3 boilers with:
    - Flanges, M12/16 bolts, nuts, spring washers and gaskets
    - 35 mm blind covers for unused boiler connections
  - DN50 or DN65 gas pipe work header for 2 or 3 boilers with:
    - Flanges, M12 bolts, nuts, spring washers and gaskets
    - 1¼" blind covers for unused boiler connections
    - M6x8x16 close tolerance bolts for fastening gas pipeline
  - Adjustable feet M8x35
2. Boiler connection set
  - Couplings and pipe branches
  - Isolation valves
  - Supply and drainage tap with T-piece;
3. Boiler connection set for connecting external boiler
  - Three-way valve (only when boiler supplies hot water)
4. Low velocity header
  - DN65 or DN100 Low velocity header with:
    - Adjustable feet, bolts, nuts, spring washers and gaskets
    - Automatic air vent, sensor pocket for T10 and drain valve
5. Frame (if stand-alone)
  - Assembly frame (for 1 boiler in line or 2 boilers back to back)
  - I-column(s)
  - L-column(s) (for back- to- back positioning)
  - Adjustable feet, bolts, spring washers and nuts
6. Parts such as: Bus communication cable, insulation.





## 5 Installation and mounting



**Install the boiler in a well-ventilated boiler room in accordance to the actual local regulations BS6644:2005.**

The installation location of the CH-boiler(s) has to be, and remain, frost-free. It is NOT necessary to have a purpose provided air vent providing a twin pipe or concentric room sealed flue system is used in the room or internal space in which the boiler is installed. Neither is it necessary to ventilate the compartment in which the boiler is installed, due to the extremely low surface temperature of the boiler casing during operation. Therefore the requirements of BS 6798, Clause 12, and BS5440:2 may be disregarded.

The floor has to be flat and level and have sufficient deadweight capacity for the complete (filled) installation.

The ATAG XL cascade can be mounted in 3 ways:

- Wall-mounted in line                      All boilers alongside one another on the wall  
*Refer to chapter 5.1 and 5.4*
- free-standing in line                      All boilers hanging alongside one another on a free-standing frame.                      *Refer to chapter 5.2 and 5.4*
- free-standing back-to-back.              All boilers hanging back-to-back on a free-standing frame.                      *Refer to chapter 5.3 and 5.4*



General guidelines:

**Pay attention to the minimum distance required between the boilers, walls and ceiling for installing and removing the housing (refer to fig. 5.a.) for commissioning and servicing and installing the flue system (refer to chapter 7).**

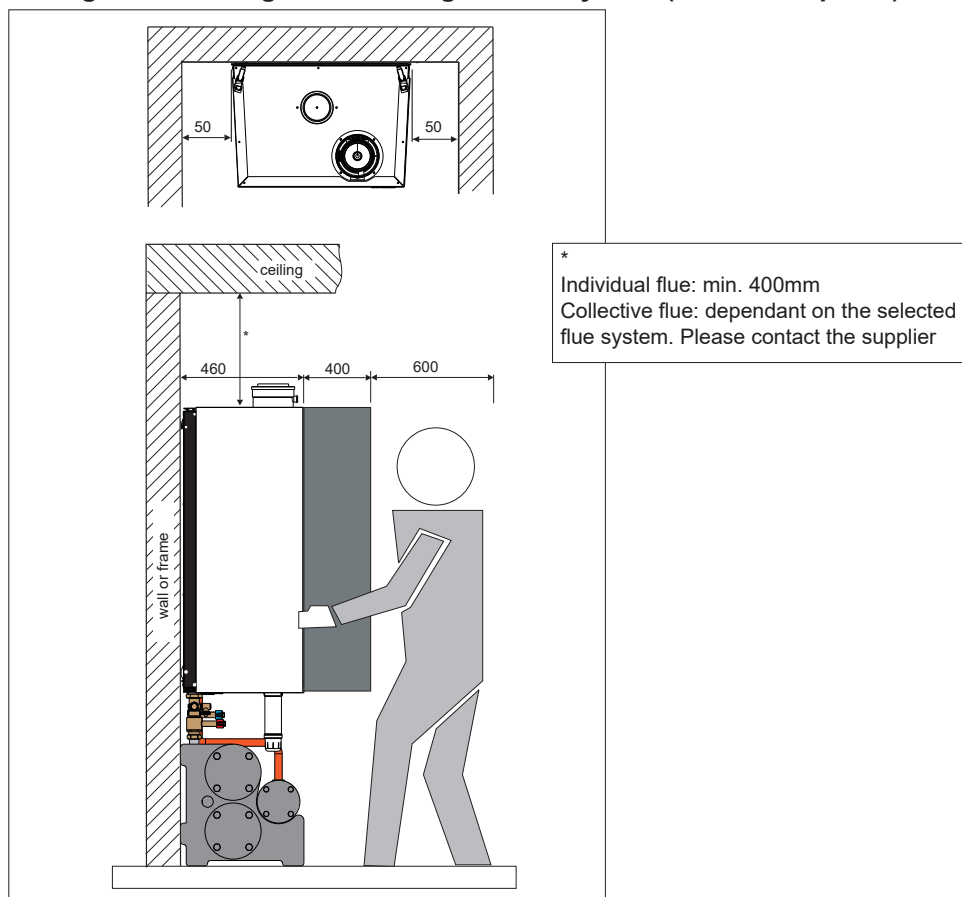

Figure 5.a

measurements in mm

If you have opted to build the hydraulic part yourself, then ATAG recommends using a boiler connection set AX00480U (Connection set XL as single boiler) for each boiler. In that case, the connection measurements are:

- Flow and return line                      ø35mm compression fitting
- Gas line    ø28mm compression fitting

## 5.1 Wall-mounted in line



Figure 5.1.a

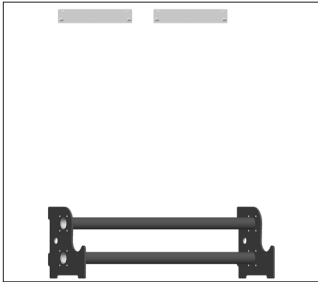

Figure 5.1.b

A. Position the pipe work header against the wall. When using several pipe work headers: couple the pipe work headers and supplied gaskets, M12 (DN65) or M16 (DN100) bolts, spring washers and nuts. Align the pipe work header(s) horizontally using the adjustable feet.

B. Determine the position of the suspension brackets based on figure 5.1.c. The boilers can be fitted on the wall using the supplied suspension brackets and mounting material (minimum of 3 screws for each boiler). The wall has to be flat and strong enough to carry the weight of all boilers including their water contents.

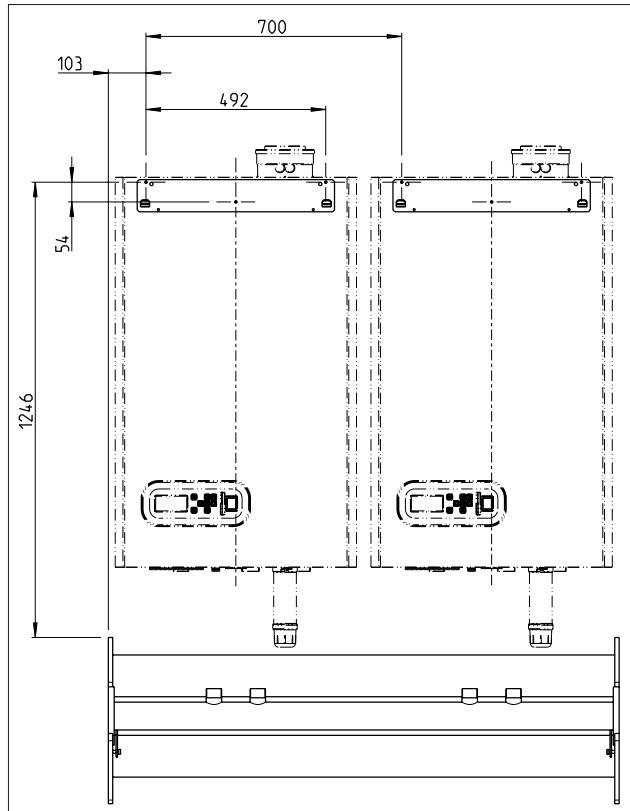

Figure 5.1.c

measurements in mm

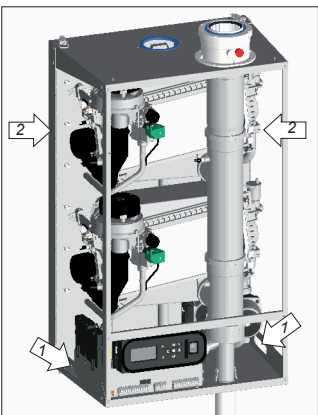

Figure 5.1.d

C. Hang the boilers on the suspension brackets.



**Lift the boiler only by the special grips on the bottom panel (1) and support the boiler by its rear panel (2). Refer to figure 5.1.d.**

### Lifting and carrying precautions:

- Lift only a manageable weight, or ask for help.
- When lifting the boiler, bend the knees, and keep the back straight and feet apart.
- Do not lift and twist at the same time.
- Lift and carry the boiler close to the body.
- Wear protective clothing and gloves to protect from any sharp edges.

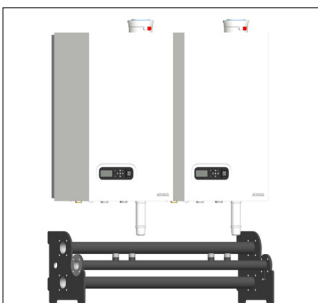

Figure 5.1.e

D. Place the gas line in its intended recess. When using several pipe work headers: couple the gas lines using the supplied DN50/DN65 gaskets, M12 bolts, spring washers and nuts. Refer to figure 5.1.e.



Figure 5.1.f



**Fasten the gas line with the 2 special close tolerance bolts M6x8x16 on each flange of the pipe work header(s). Refer to figure 5.1.f.**

Continue with chapter 5.4



## 5.2 Free-standing in line



Figure 5.2.a

A. Position the pipe work header in the required location. When using several pipe work headers: couple the pipe work headers using the supplied gaskets, M12 (DN65) or M16 (DN100) bolts, spring washers and nuts. Align the pipe work header(s) horizontally using the adjustable feet.



Figure 5.2.b

B. Place the gas line in its intended recess. When using several pipe work headers: couple the gas lines using the supplied DN50/DN65 gaskets, M12 bolts, spring washers and nuts. Refer to figure 5.2.b.



Figure 5.2.c

**⚠ Fasten the gas line with the 2 special close tolerance bolts M6x8x16 on each flange of the pipe work header(s). Refer to figure 5.2.c.**



Figure 5.2.d

C. Fit the I-columns on the flange plate using 2x bolts M8x40x70mm.

**Attention: Use the correct holes in the column!**



**When using a left flange plate: use the right-hand holes in the column.**

**When using a right-hand flange plate: use the left-hand holes in the column.**

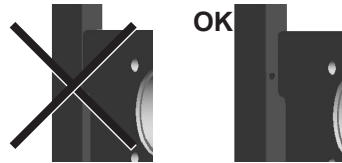

D. Fit a mounting frame on the I-column using 3-x bolt M8x50mm. Refer to figure 5.2.e.

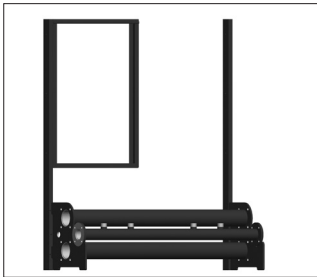
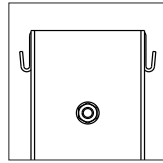

Figure 5.2.e



**Attention: mounting rail at the top.**



E. Fit a mounting frame on the other I-column using 3-x bolt M8x50mm. Refer to figure 5.2.f.

If boilers also have to be fitted on the other side of the I-column, then the next mounting frame also has to be fitted straight on it.



Figure 5.2.f

F. Fit the remaining I-column(s) between the mounting frames using 3x M8x50mm. Refer to figure 5.2.f.

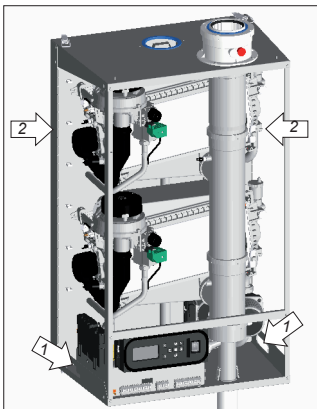

Figure 5.2.g

G. Hang the boilers on the mounting rail.



**Lift the boiler only by the special grips on the bottom panel (1) and support the boiler by its rear panel (2). Refer to figure 5.2.g.**

### Lifting and carrying precautions:

- Lift only a manageable weight, or ask for help.
- When lifting the boiler, bend the knees, and keep the back straight and feet apart.
- Do not lift and twist at the same time.
- Lift and carry the boiler close to the body.
- Wear protective clothing and gloves to protect from any sharp edges.

Continue with chapter 5.4

## 5.3 Free-standing back-to-back

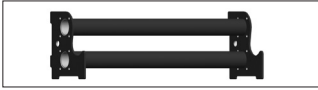

Figure 5.3.a

A. Position the pipe work header in the required location. When using several pipe work headers: couple the pipe work headers with the supplied gaskets, M12 (DN65) or M16 (DN100) bolts, spring washers and nuts. Align the pipe work header(s) horizontally using the adjustable feet.



Figure 5.3.b

B. Place the gas line in its intended recess. When using several pipe work headers: Couple the gas lines using the supplied DN50/DN65 gaskets, M12 bolts, spring washers and nuts. Refer to figure 5.3.b.



Figure 5.3.c

**⚠ Fasten the gas line with the 2 special close tolerance bolts M6x8x16 on each flange of the pipe work header(s). Refer to figure 5.3.c.**

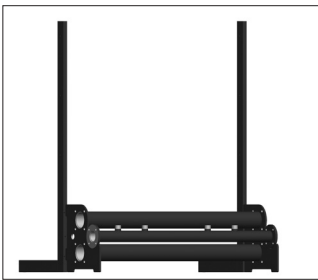
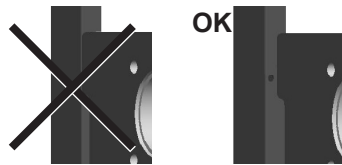

Figure 5.3.d

C. Fit the L-columns on the flange plate using 2 x bolts M8x40x70mm.  
**⚠ Attention: Use the correct holes in the column!**  
**When using a left flange plate: use the right-hand holes in the column.**  
**When using a right-hand flange plate: use the left-hand holes in the column.**



D. Fit a mounting frame on the L-column using 3x bolt M8x50mm. Refer to figure 5.3.e.

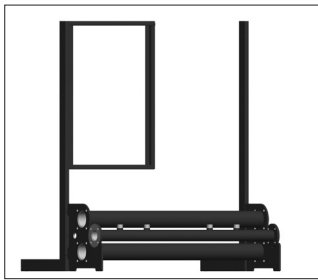
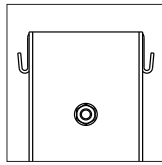

Figure 5.3.e

**⚠ Attention: mounting rail at the top.**



E. Fit a mounting frame on the other L-column using 3-x bolt M8x50mm. Refer to figure 5.3.f.  
If boilers also have to be fitted on the other side of the L-column then the next mounting frame also has to be fitted straight on it.



Figure 5.3.f

F. Fit the remaining L-column(s) between the mounting frames using 3x M8x50mm. Refer to figure 5.3.f.

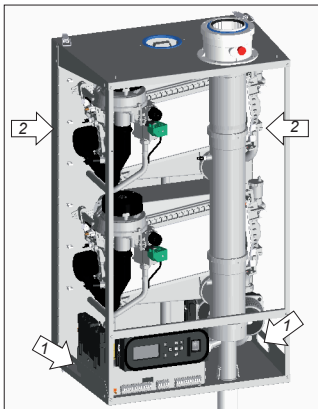

Figure 5.3.g

G. Hang the boilers on the front and rear of the frame on the mounting rail.

**⚠ Lift the boiler only by the special grips on the bottom panel (1) and support the boiler by its rear panel (2). Refer to figure 5.3.g.**

### Lifting and carrying precautions:

- Lift only a manageable weight, or ask for help.
- When lifting the boiler, bend the knees, and keep the back straight and feet apart.
- Do not lift and twist at the same time.
- Lift and carry the boiler close to the body.
- Wear protective clothing and gloves to protect from any sharp edges.

Continue with chapter 5.4

## 5.4 Connecting the boiler

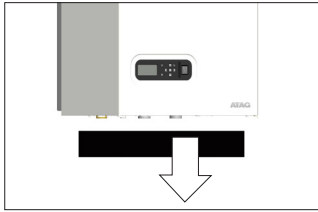

Figure 5.4.a

- A. Remove the remaining packaging part from the bottom of the boiler.



**Note: this packaging part is provided with boiler parts which are needed for mounting the boiler.**

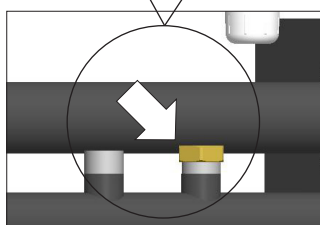
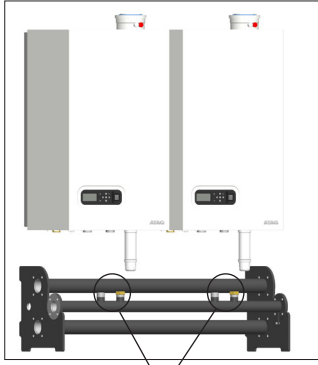

Figure 5.4.b

- B. Cap the connections that are not used on the pipe work headers:

Flow and return:	ø35mm blind compression fitting	(2 items/boiler)
Gas:	1 ¼" blind cap with gasket	(1 item/boiler)



**For connections, use the supplied gaskets. Check all connections for leakage and gas-tightness.**

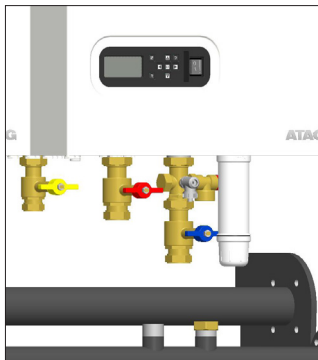

Figure 5.4.c

- C. Connecting the isolation valves to the boiler:

Flow: 1½" flat coupling x 35mm compression isolation valve with red handle  
 Return: 1½" flat coupling x 35mm compression fitting cross union with fill/drain valve and isolation valve with blue handle

The boiler is supplied with a 3 and 4 bar safety valve.

ATAG UK recommend fitting the 4 bar safety valve due to the control settings shutting the boiler off at 3.8 bar.

Gas: 1¼" x 28mm gas isolation valve



**Polluted test water may be released when removing the plastic caps on the boiler flow and return.**



**For connections, use the supplied gaskets. Check all connections for leakage and gas-tightness.**

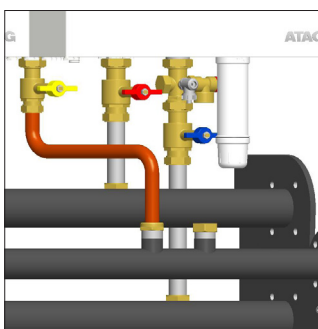

Figure 5.4.d

- D. Connect the valves to the pipe work headers:

Flow: 35mm pipe pieces with 35mm compression fittings (elbow and socket)

Return: 35mm pipe pieces with 35mm compression fittings (elbow and socket)

Gas: 28mm pipe piece with 1¼" flat and 28mm compression fitting

Back-to-back installation:

Flow: 35mm pipe pieces with 35mm compression fittings (bend and socket)

Return: 35mm pipe pieces with 35mm compression fittings (bend and socket)

Gas: 28mm pipe piece with 1¼" flat and 28mm compression fitting



**For connections, use the supplied gaskets. Check all connections for leakage and gas-tightness.**

- E. Fill the siphon with tap water and fit the siphon cup underneath the boiler.  
*The siphon cup is supplied separately and can be found behind the housing.*

## 6 Hydraulic and gas pipe line system

### 6.1 Heating system

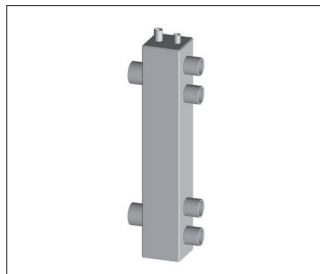

Figure 6.1.a

Install the CH-system in accordance with present legislation.

The pipe work headers are available in 2 dimensions, i.e. DN65 and DN100 and are connected to one another by the flange couplings and gaskets, M12 or M16x55 bolts, spring washers and nuts. The low velocity header and the complete installation can then be connected to it.

#### Low velocity header

There are 3 low velocity headers available:

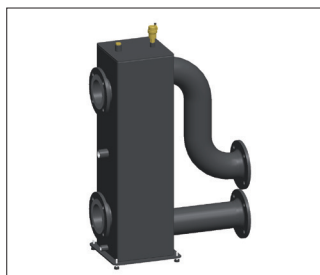

Figure 6.1.b

AX00470U Low velocity header for 1 or 2 XL boilers to max. 200kW (fig. 6.1.a) supplied with automatic air vent, drain valve and pocket for temperature sensor T10. Boiler connections are 4x 1 1/2", installation connections are 2x 2". The low velocity header **MUST** be connected between the boiler[s] and the system pumps.

AX00120U Low velocity headers DN65 to 452kW (fig. 6.1.b)

AX00130U Low velocity headers DN100 to 960kW

The low velocity headers comes standard with adjustable feet, automatic air vent, drain valve, pocket for temperature sensor T10, M12 or M16x55 bolts, spring washers and nuts. The low velocity header can be positioned on either the left or right hand side of the pipe work headers.



Figure 6.1.c

AX00630U Flow temperature sensor T10 (fig. 6.1.c)



**Every system with 1 or more XL-boilers must be provided with a flow temperature sensor T10 and must be connected on the master boiler (address 01) to terminal 3, position 5 and 6. The flow sensor must be placed in the pocket of the low velocity header.**



Figure 6.1.d

#### Set of bends

The low velocity header can be positioned at a 90° angle. A set of bends may be used for that purpose.

AX00300U Bends set DN65 flow/return (fig. 6.1.d)

AX00310U Bends set DN100 flow/return



Figure 6.1.e

#### Blanking flanges

The ends of the pipe work headers have to be fitted with blanking flanges. The blanking flanges come standard with a fully configured delivery, including bolts, spring washers and gaskets.

AX00320U Blanking flange set DN65 flow/return 2 items (fig. 6.1.e)

AX00330U Blanking flange set DN100 flow/return 2 items



Figure 6.1.f

#### Welded-on flanges

Upon request, welded-on flanges are available to connect CH-pipe lines to the secondary side of the low velocity header and to connect the gas line.

AX00680U Welded-on flange set DN65 flow/return 2 items + DN50 gas 1 item (fig. 6.1.f)

AX00690U Welded-on flange set DN100 flow/return 2 items + DN65 gas 1 item

Required components that are not supplied by ATAG:

- The installation pump;
- The installation water filter;
- Gas filter;
- Regulation valve;
- Expansion vessel(s);
- The condensate discharge system.
- Air and dirt separator
- Hot water supply
- Flue system

## 6.2 Expansion vessel

The CH-installation has to be fitted with an expansion vessel. The expansion vessel used has to comply with the water contents of the installation.

It is not necessary to install an expansion vessel to each boiler. One single, central installed expansion vessel is sufficient. When using a single expansion vessel the handles of the valves on the flow and return pipes below the boiler have to be removed whilst open.

A boiler expansion vessel can be connected on the cross union inside the return pipe to each boiler, if required. The connection is fitted with a 3/4" outer thread blanking cap.

### Expansion DHW cylinder circuit

When applying a DHW cylinder connected directly to the boiler (ATAG cylinder connection with use of 3-way valve) the circuit between the three-way valve and the separation of the DHW cylinder should be provided of an expansion tank.

## 6.3 Water quality

Fill the installation with drinking water.

In most cases, a heating system can be filled with water according to national standards for water and treatment of this water is not necessary.

In order to avoid problems with the CH-installations, the quality of the filling water has to meet the specifications mentioned in table 6.3.a:

If the filling water does not meet the required specifications, you are advised to treat the water to such an extent that it does meet the required specifications.



**The warranty becomes invalid, if the installation is not being flushed and/or the quality of the filling water does not meet the specifications recommended by ATAG. Always contact ATAG in advance, if things are not clear or you wish to discuss any deviations. Without approval, the warranty becomes invalid.**

### Installation:

- The use of groundwater, demi-water and distilled water is prohibited. (on the next page you will find an explanation of these definitions)
- If the drinking water quality meets the specifications mentioned in table 1, you can start flushing the installation before installing the boiler(s).
- Whilst flushing, corrosion products (magnetite), fitting products, cutting oil and other undesirable products have to be removed.
- Another possibility is to remove the pollution by installing a filter. The filter type has to fit the type and grain size of the pollution. ATAG recommends filter usage.
- In this case, the whole piping system should be taken into consideration.
- The CH-installation has to be properly vented before using the system. For that purpose, we refer to the commissioning chapter.
- If a regular water top up is required (>5% on an annual basis), then there is a structural problem and an installer has to solve the problem. Regularly adding fresh water to the system also adds additional calcium and oxygen implying that magnetite and calcium residues can continue. The result may be blockages and/or leakages.
- The use of anti-freeze and other additives requires periodical quality checks of the filling water in accordance with the period laid down by the additives supplier.

- Chemical additions are to be avoided and should only be used after ATAG HEATING has approved their corresponding use.
- Should you wish to achieve the required water quality by using chemical additives, then this is your own responsibility. The warranty on the product delivered by ATAG expires, if the water quality does not meet ATAG's specifications or the chemical additives have not been approved by ATAG.
- On installation and during additions or changes at a later stage, ATAG recommends to keep a record of the type of water used, its quality at the time, and if applicable, which additives and quantities were added.

Parameter	Value
Water type	Potable water Softened water
pH	6.0-8.5
Conductivity (at 20°C in µS/cm)	Max. 2500
Iron (ppm)	Max. 0.2
Hardness (°dH):	
Installation volume/capacity <20 l/kW	1-12
Installation volume/capacity >=20 l/kW	1-7
Oxygen	No oxygen diffusion allowed during operation. Max. 5% filling water addition annually
Corrosion inhibitors	Refer to Additives Attachment
pH increasing or lowering agents	Refer to Additives Attachment
Anti-freeze additives	Refer to Additives Attachment
Other chemical additives	Refer to Additives Attachment
Solid substances	Not allowed
Residues of processing water not forming part of the drinking water	Not allowed

table 6.3.a

**Water type definition:**

- Potable water: Tap water compliant with the European drinking water guideline: 98/83/EG dated 3 November 1998.
- Softened water: Water with partly de-ionised calcium and magnesium.
- Demi-water: Virtually completely demineralised water (very low conductivity)
- Distilled water: Water no longer containing minerals.

## 6.4 Gas line

Mount the gas line in accordance with present legislation.  
If required, mark the gas line in accordance with present legislation.

### **United Kingdom:**

The gas supply must comply to the current Gas Safety, Installation & Use Regulations.

### **Ireland:**

- Irish standard 813
- Domestic gas installations

The gas line leading to the installation has to be calculated to the maximum capacity to determine the diameter of the supply pipe.

The gas line has to be placed on the allocated openings of the flange plates of the pipe work headers flow/return and secured on all flange plates by the special M6x8x16 close tolerance bolts.

Pressure loss for a newly installed natural gas line may be 1.7 mbar max. In the case of an extension, this may be 2.5 mbar max. This value is to be measured in between the operational gas meter and the CH-boilers.

For correct functioning of the boilers, it is necessary that the gas dynamic inlet pressure must be at least 19 mbars.



**With regard to new lines in particular, ensure that the gas line does not contain any residual pollution.**



### **LPG**

When the boiler has to be converted from natural gas to LPG, ATAG provides special kits for this purpose. Special instructions are supplied with the kit.



**Following maintenance tasks always check all gas carrying components for leakages by using of leakage detection fluid (LDF).**

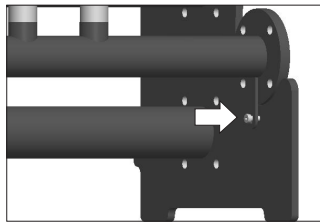

Figuur 6.4.a



## 6.5 Condensate drain

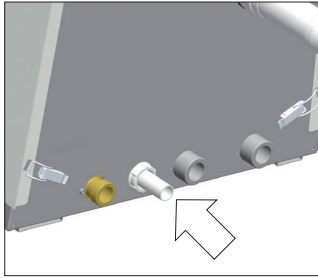

Figuur 6.5.a

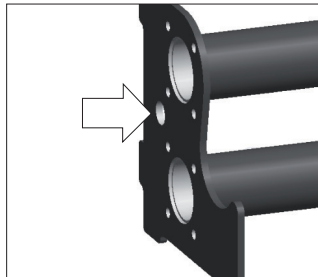

Figuur 6.5.b

All ATAG wall hung gas fired condensing boilers contain a siphonic condensate trap to collect and release condensate.

The amount of condensate formed is determined by the type of boilers and the water temperature produced by the boiler.

### **Condensate pipework.**

Press the supplied plastic ribbon tube onto the condensate drain at the bottom of the boiler (fig. 6.5.a). Connect the tube to the main condensate drain (minimum diameter=40mm) by means of an open connection to avoid sewage gasses coming into the boiler.

Fit a pipe work header for the condensate drain behind the hydraulic system. For that purpose, the flange plates have holes allowing the installation of a PVC drain of  $\varnothing 40\text{mm}$  max. Use this drain to connect the individual condensate drains of each boiler.

The siphon of a flue gas system can also be connected, if required, by means of an open connection.

### **Routing of the pipework.**

Wherever possible, the condensate pipework should be routed internally to prevent freezing.

The condensate pipework must fall at least 50mm per metre towards the outlet and take the shortest possible route

Support the pipe at least every 50 cm for near horizontal sections and 1 metre for vertical sections

### **External pipework**

The pipework should be kept to a minimum and the route as vertical as possible. Do not exceed 3 metres outside the dwelling.

The condensate pipe must be run using suitable corrosion resistant materials (eg. plastic).

Terminate as close to the ground or drain as possible (below the grating and above the water level) while still allowing for safe dispersal of the condensate.

Connection of a condensate drainage pipe to a drain may be subject to local building controls.

Pipework subjected to extreme cold or wind chill conditions should be in a 40mm diameter pipe.

Protect all external pipework with weather resistant insulation and, if necessary, box in, to reduce the risk of freezing.

### **Making it safe.**

Condensate pipework must not leak, freeze or block up.

Condensate traps must be filled before firing the boiler to prevent the possibility of potential harmful flue products evacuating via the condensate route.

Do not dispose condensate into a water recovery system where it is reclaimed for reuse.

Condensate can be discharged into a rainwater hopper which is part of a sewer carrying both rain water and foul water.



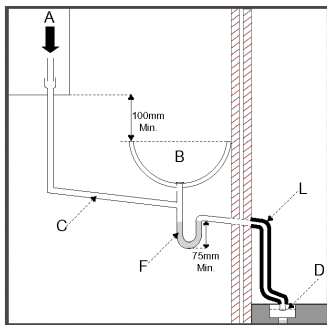

**Final discharge options.**

The condensate pipe can only terminate into any one of the five areas as shown in the diagrams on this page.



**Draining of the condensation water to the external rain guttering is not permitted in view of the danger of freezing.**



**Before putting the boiler into operation fill the siphon with 600 ml of water.**

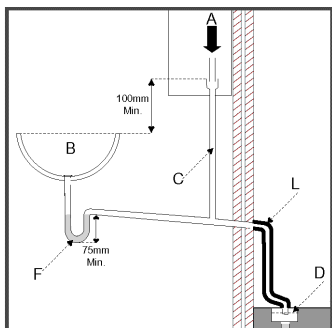
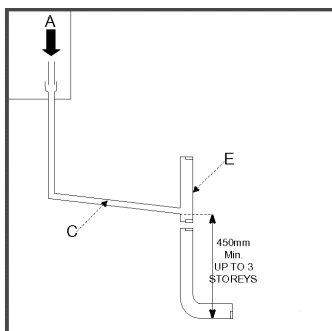
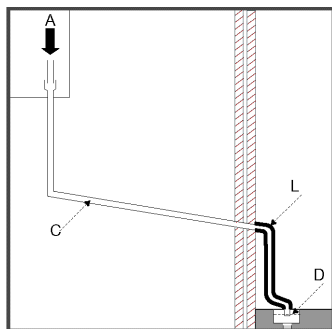

- A -Condensate from boiler siphon/trap
- B -Sink with internal overflow
- C -25mm dia. Plastic condensate pipe
- D -External drain or gully
- E -Internal soil and vent stack.
- F -Serviceable condensate trap (75mm min.)
- G -300mm x 100mm dia. sealed plastic tube.
- H -Ground level
- J -Drainage holes facing away from the building
- K -Lime stone chippings
- L -Weather resistant insulation

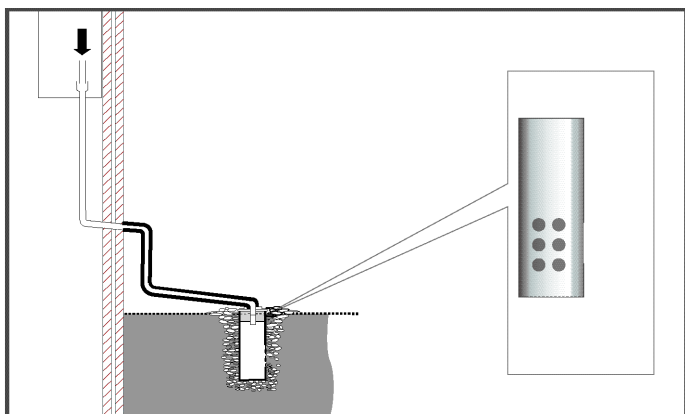

Drain requirements

figure 6.4.c

## 6.6 Hot water supply

The hot water supply control can be connected to the ATAG XL. For connection and settings refer to the Boiler Control chapter.

### Expansion DHW cylinder circuit

When connecting a DHW cylinder to the boiler before the low velocity header an ATAG three way valve is recommended.

The circuit between the three way valve [A] and the separation device [B] between the boiler and cylinder should be provided with an expansion vessel [C]. See figure 6.6.b.

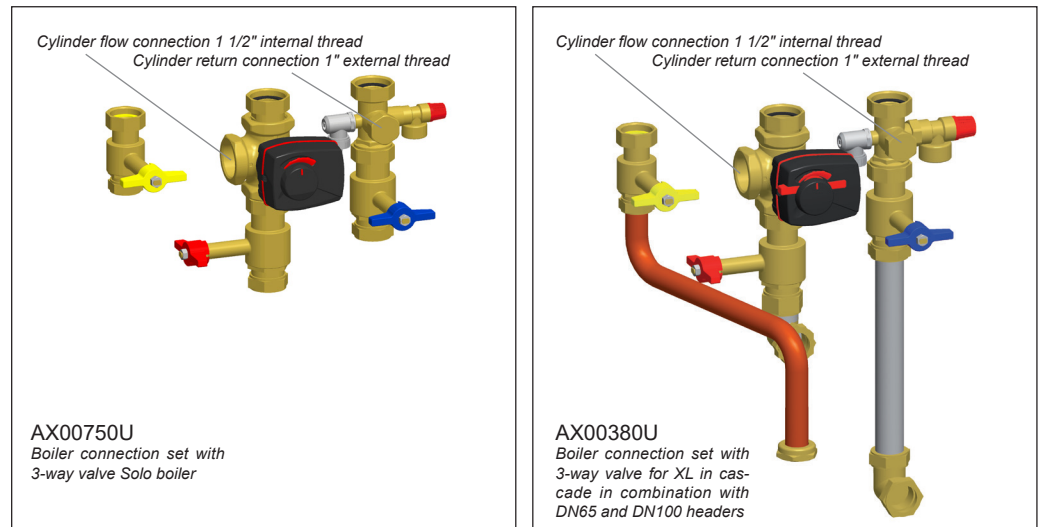

Figure 6.6.a

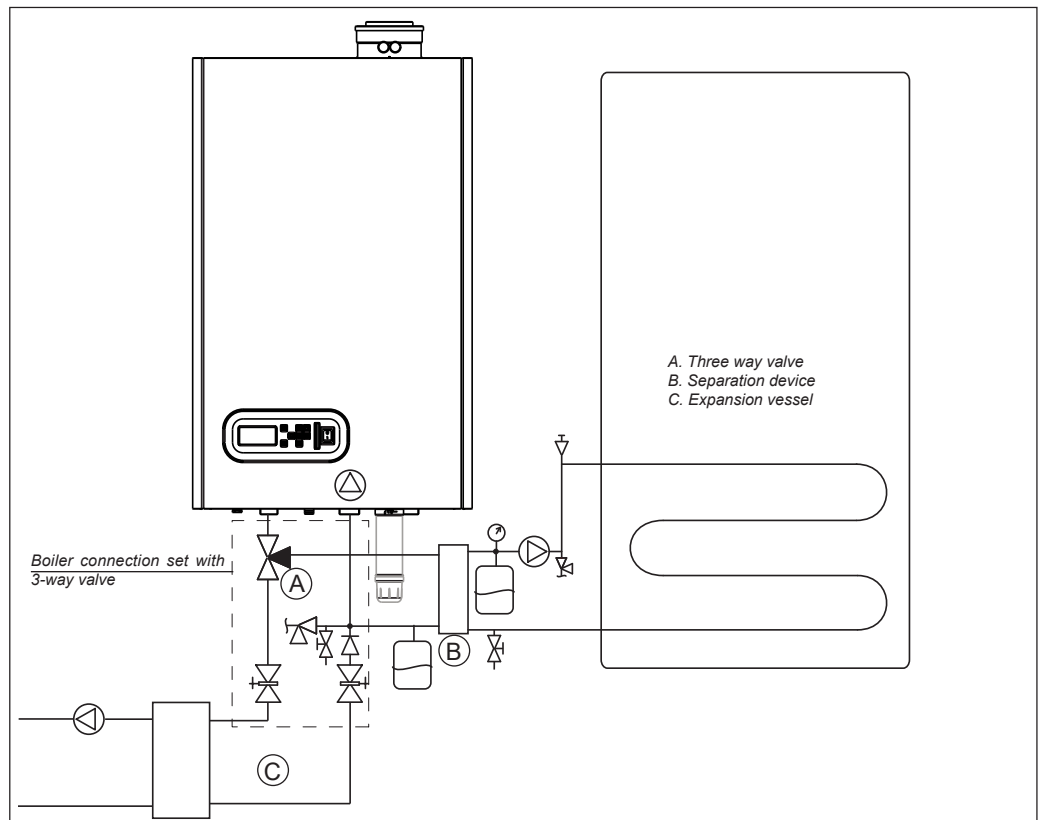

Figure 6.6.b

Boiler type	XL70	XL110	XL140
Pump head for DHW	25	20	20

## 7 Flue gas system

The flue gas exhaust system and air supply system consists of:

- Flue gas pipe;
- Air supply pipe;
- Roof or wall terminal.

The flue gas exhaust system and air supply system must comply with:

### **United Kingdom:**

The flue gas outlet and air supply installation must comply with the current regulation requirements:

IGE/UP/10;	Installation of flued gas appliances in industrial and commercial premises
BS EN 1856-1;	Chimneys - Requirements for metal chimneys - Part 1: System chimney products
BS EN 1856-2;	Chimneys - Requirements for metal chimneys - Part 2: Metal liners and connecting flue pipes
BS EN 15287-1;	Chimneys - Design, installation and commissioning of chimneys - Part 1: Chimneys for non-room sealed appliances
BS EN 15287-2;	Chimneys - Design, installation and commissioning of chimneys - Part 1: Chimneys for room sealed appliances
BS EN 13384-2;	Chimney - Thermal and fluid dynamic calculation methods - Part 2: Chimneys serving more than one heating appliance
Clean Air Act;	For multiple boiler application where total heat input exceeds 366.4 kW [ or 150 kW as advised within the CAAM, refer to local authority ]

### **Ireland:**

- Irish standard is 813 section 9.10.1

Furthermore:



- **Boiler Class indicated on the boiler's type plate (Flue category)**
- Locally applicable rules.
- The supplier's installation instructions



**When in doubt or if you have any questions, always contact ATAG HEATING.**

The boiler can be fitted with a parallel connected flue gas outlet and air supply system (the connection diameter for both channels is  $\varnothing 100\text{mm}$ ) or a concentric flue gas outlet and air supply system. In that case, the connection diameter is  $\varnothing 100/150\text{mm}$ . Refer to chapter 7.1 or 7.2.

## 7.1 Parallel boiler connection

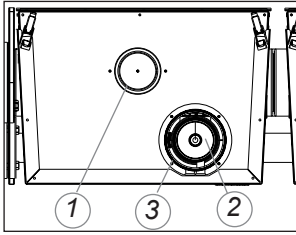

Figure 7.1.a

The boiler comes as standard with a parallel connection for the flue gas outlet and air supply system.

The air supply opening (1) has a diameter of  $\varnothing 100\text{mm}$ .

The air supply channel can be connected to it, or, if it involves an “open device” (Drainage category B), an air filter must be fitted.

The air supply (3) of the concentric part is closed by a lid  $\varnothing 150\text{mm}$ .

The flue gas outlet connection (2) has a diameter of  $\varnothing 100\text{mm}$ .

## 7.2 Concentric boiler connection

Carry out the following tasks to convert the boiler to a concentric connection.

- Remove the lid  $\varnothing 150$  (3) from the air supply connection of the concentric connection component (2).
- Fit the lid  $\varnothing 100$  on the air supply opening (1) and secure it with the screw (all parts are delivered separately in the foam wrapping underneath the boiler)

The air supply opening has a diameter of  $\varnothing 150\text{mm}$ .

The flue gas outlet connection has a diameter of  $\varnothing 100\text{mm}$ .

The flue gas outlet-/air supply system is then connected to the concentric connection component.

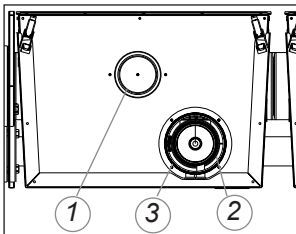

Figure 7.2.a

## 7.3 Connecting the flue gas outlet-/air supply system

XL-boilers can be used both in an "open" and in "closed" system.

**Open:** The required combustion air is taken from the immediate environment (boiler room). For this purpose, please comply with the applicable boiler room ventilation regulations BS 6644.



**When using boiler category B23 and B33 as an 'open boiler', the protection degree of the boiler will be IPX0D instead of IPX4D. An air filter must be fitted on the air intake of the boiler (available as an accessory with art.nr. AX00540U).**

**Closed:** The required combustion air is sucked in from the outside through a channel. This improves installation possibilities within a building. In general, outside air is cleaner than air from the boiler room.

The following flue gas outlet systems can be used for the XL-boiler:

- Individual flue gas outlet See chapter 7.4
- Collective flue gas outlet under-pressure See chapter 7.5, 7.5.1 and 7.6
- Collective flue gas outlet over-pressure See chapter 7.5, 7.5.2 and 7.6

## 7.4 Individual flue gas outlet

Opting for an individual flue gas outlet is determined by:

- Favourable position of boilers with regard to outlet area (wall or roof)
- Limited space above the boilers
- Limited number of boilers

We suggest you design a simple flue gas system and air supply system. For further information about the available components of the flue gas and air supply system we recommend you consult the ATAG Duopass flue literature.

ATAG supplies the following roof and wall ducts:

RV15RPS0 Roof terminal Ø100 - 150 PP - MZ  
RV15WPS0 Wall terminal Ø100 - 150 PP - MW

The flue gas systems described in this document are solely suited for ATAG central heating boilers. For this purpose the CE Certificate has been supplemented under the Gastec nr: 0063BQ3021, 0063BT3195 and 0063CM3648.

The flue gas system should be built up using only ATAG Duopass program products. Combinations with other brands or systems, without permission in writing from ATAG Heating UK, are not allowed.



**When the boiler is operational, it produces a white plume of condensation. This condensation plume is harmless but may cause some inconvenience, particularly in the case of wall terminal. As a result, roof terminals are preferred.**



**In a closed installation, roof terminals should be at the same height preventing flue gas from being sucked in by the other boiler (recirculation). Outlets in recesses and near erected walls may also bring about flue gas recirculation. Recirculation has to be prevented at all times.**

The ATAG flue gas system is meant, and designed, solely for the use on ATAG central heating boilers adjusted to Nat gas or LPG. The maximum flue gas temperatures are below 70°C (full load 80/60°C)

The proper operation may be adversely influenced by changes of or adjustments to the correct set up.

Possible warranty claims will not be honoured if incorrect changes result in non compliance with the installation manual or local rules and regulations.

The terminal should be located where dispersal of combustion products is not unimpeded and with due regard for the damage or discolouration that might occur to parts of the building in the vicinity (see fig 7.4.a).

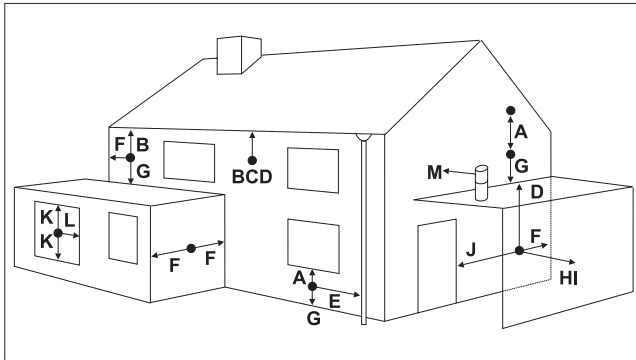

figure 7.4.a

terminal position for fan assisted boiler	minimum distance
<b>A</b> directly below an open window or other opening (e.g. air brick)	mm 300
<b>B</b> below gutters, soil pipes or drain pipes	mm 75
<b>C</b> below eaves	mm 200
<b>D</b> below balconies or car port roof	mm 200
<b>E</b> from vertical drain pipes and soil pipes	mm 75
<b>F</b> from internal or external corners	mm 300
<b>G</b> above ground or below balcony level	mm 300
<b>H</b> from a surface facing a terminal	mm 600
<b>I</b> from a terminal facing a terminal	mm 1200
<b>J</b> from an opening in the car port (e.g. door window) into dwelling	mm 1200
<b>K</b> vertically from a terminal on the same wall	mm 1500
<b>L</b> horizontally from a terminal on the same wall	mm 300
<b>M</b> horizontally from a vertical terminal to a wall	mm 300

Dimensions

table 7.4.a

In certain weather conditions condensation may also accumulate on the outside of the air inlet pipe. Such conditions must be considered and where necessary insulation of the inlet pipe may be required.

In cold and/or humid weather water vapour may condense on leaving the flue terminal. The effect of such 'pluming' must be considered.

The terminal must not be located in a place where it is likely to cause a nuisance. For protection of combustibles, refer to IS 813 section 9.10.1. where the terminal is less than 2m ( 6.6ft ) above a pavement or platform to which people have access ( including ) any balcony or flat roof. The terminal must be protected by a guard of durable material. A suitable guard is available from the country distributor.

 **Where a terminal is fitted below a window which is hinged at the top, and where the hinge axis is horizontal, and the window opens outwards, the terminal shall be 1m below the bottom of the window opening.**

 **If the boiler is to be located under stairs, a smoke alarm meeting the requirements of I.S. 409 or equivalent must be fitted.**

 **The flue must be terminated in a place not likely to cause a nuisance.**

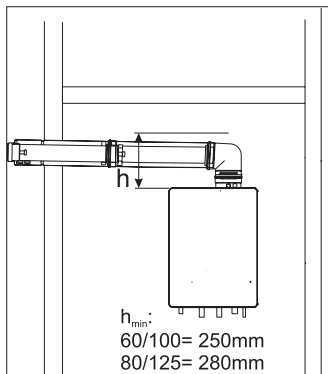

Installation height Figure 7.4.b

For horizontal sections, the outlet system should always be fitted on an incline (50 mm/m) sloping down towards the appliance so that no condensation water is able to accumulate in the outlet system. The chances of icicles forming on the roof outlet is minimised by causing the condensation water to run back towards the appliance. In the case of horizontal outlets the inlet system should be fitted on an incline sloping down towards the outside to prevent rainwater from coming in.

The appliance produces a white wisp of condensate (plumeing). This wisp of condensation is harmless, but can be unattractive, particularly in the case of outlets in outside walls. For wall terminals a plume management kit is available as an option.

Cutting the pipe goes as follows:

- Cut just as much from the air intake part as from the flue gas part using a hand saw;
- Take off the burrs from the cutting edge to prevent cutting the seals;

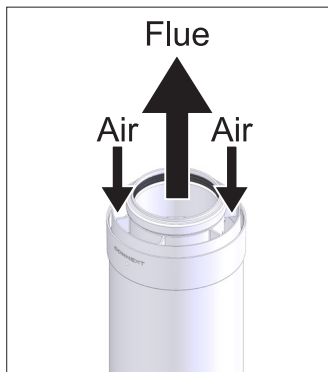

Flow direction Figure 7.4.c

When mounting the flue gas system, pay attention to the flow direction (See figure 7.4.c). It is not permitted to mount a system upside down and will lead to complaints.

Use a soap solvent or special grease to simplify the fitting.

Refer to table 7.4.a for maximum applicable pipe length.

Example:

An XL70 with a concentric flue gas system  $\phi 100/150\text{mm}$  has according to the table a maximum flue straight length of 25m. In the system that is going to be put in there are 2 x 45° bends, so the maximum flue gas length is  $25 - (2 \times -1.3) = 22.4$  meters.

Two pipe flue system + chimney lining		
		A in m
XL70	Maximum straight length 100	63
	87° bend resistance length	-2,1
	45° bend resistance length	-2
XL110	Maximum straight length 100	35
	87° bend resistance length	-2,1
	45° bend resistance length	-2
XL140	Maximum straight length 100	12
	87° bend resistance length	-2,1
	45° bend resistance length	-2

Concentric flue system		
		B in m
XL70	Maximum straight length 100/150	25
	87° bend resistance length	-1,7
	45° bend resistance length	-1,3
XL110	Maximum straight length 100/150	15
	87° bend resistance length	-1,7
	45° bend resistance length	-1,3
XL140	Maximum straight length 100/150	8
	87° bend resistance length	-1,7
	45° bend resistance length	-1,3

Maximum flue length for individual flue gas outlet

table 7.4.a

## 7.5 Collective flue gas outlet

Opting for a collective flue gas outlet is determined by:

- The position of the boilers with regard to their outlet area
- Sufficient space above the boilers
- Large number of boilers

You may opt for:

- Collective flue gas outlet under-pressure
- Collective flue gas outlet over-pressure

In many situations, flue gases cannot be vented individually because the installation is indoors. For such situations, we recommend collective venting by means of under-pressure or over-pressure using a flue gas outlet system. The air supply may also be supplied collectively, but if the boiler room is suitable for that purpose (refer to chapter 6.3) it may also be obtained from this area ('open device' Boiler category B).



**In the case of collective venting of flue gases, the flue gas-venting outlet always has to end up in the open area (outlet area 1).**

ATAG Heating UK can supply a collective flue gas outlet system for the ATAG XL. Refer to the following chapters with regard to the various possibilities and maximum pipe lengths that can be used.

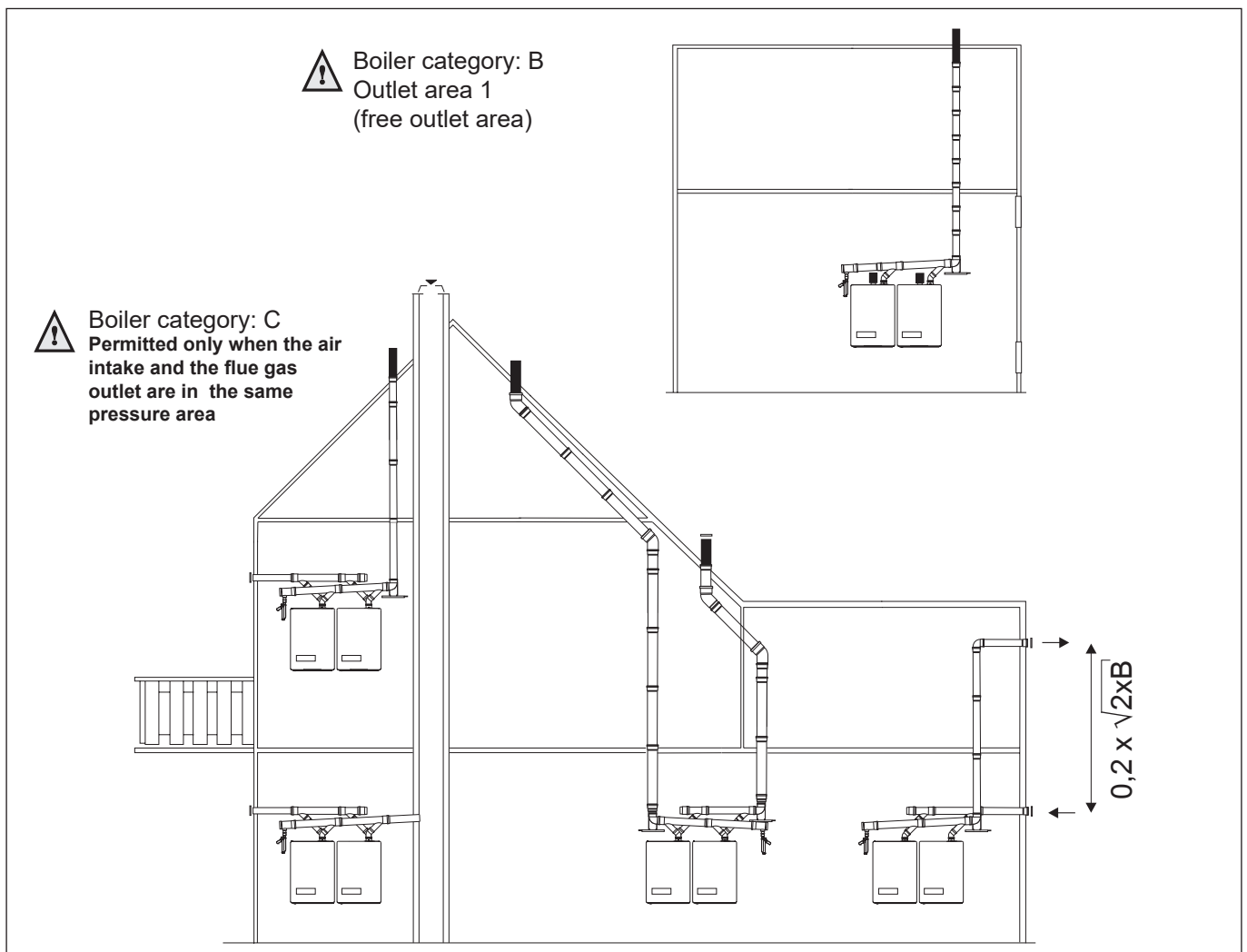

Flue outlet possibilities collective flue gas outlet

figure 7.5.a



## 7.5.1 Collective flue gas outlet under-pressure

Diameter and venting lengths of the flue gas outlet/air supply:

- Open system, with under-pressure (calculated with thermal draft) under atmospheric circumstances.

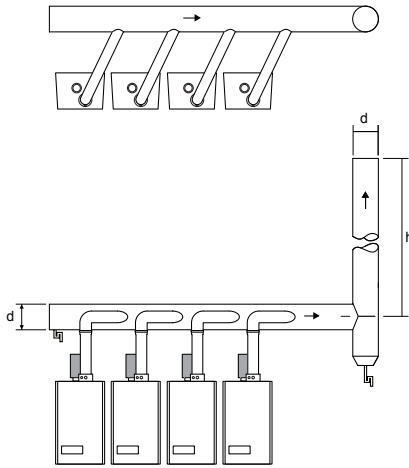

**NOTE!**  
1. IPX0D at flue category B<sub>23</sub> and B<sub>33</sub>

Table 7.5.1.a

Dimensions cascade flue ATAG XL Open system, underpressure							
Output (P) kW at 80/60°C	Type XL			d = minimum diameter Ø in mm			
	70	110	140	h = 2 - 5	h = 5 - 9	h = 9 - 13	h = 13 - 17
152	1	1		210	200	190	190
180	1		1	210	200	190	190
212		1	1	210	200	190	190
240			2	210	200	190	190
272	1	1	1	300	270	260	250
300	1		2	300	270	260	250
332		1	2	300	270	260	250
360			3	300	270	260	250
392	1	1	2	360	330	310	300
424		2	2	360	330	310	300
452		1	3	360	330	310	300
480			4	360	330	310	300
512	1	1	3	440	380	360	340
544		2	3	440	380	360	340
572		1	4	440	380	360	340
600			5	440	380	360	340
632	1	1	4	470	420	400	380
660	1		5	470	420	400	380
692		1	5	470	420	400	380
720			6	470	420	400	380
752	1	1	5	550	470	430	410
784		2	5	550	470	430	410
812		1	6	550	470	430	410
840			7	550	470	430	410
872	1	1	6	600	510	470	440
900	1		7	600	510	470	440
932		1	7	600	510	470	440
960			8	600	510	470	440

Assumptions: Trega-cap on flue outlet, cross-cap on air intake.

In case of open outlet or diffuser pressures will be better.

Tinside, Toutside= + 20C, O2= 4,7%, Trg=50C.

Diameter and venting lengths of the flue gas outlet/air supply:

- Closed system, with under-pressure (calculated with thermal draft) under atmospheric circumstances.

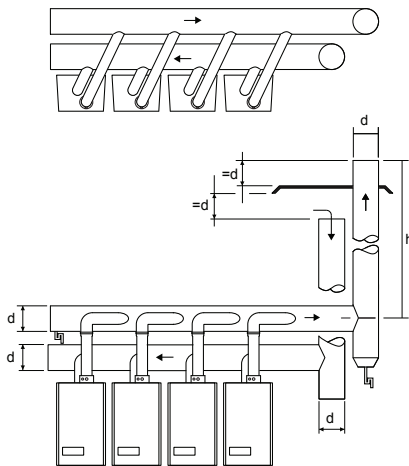

Table 7.5.1.b

Dimensions cascade flue ATAG XL Closed system, underpressure, parallel							
Output (P) kW at 80/60°C	Type XL			d = minimum diameter Ø in mm			
	70	110	140	h = 2 - 5	h = 5 - 9	h = 9 - 13	h = 13 - 17
152	1	1		240	220	220	220
180	1		1	240	220	220	220
212		1	1	240	220	220	220
240			2	240	220	220	220
272	1	1	1	330	300	290	270
300	1		2	330	300	290	270
332		1	2	330	300	290	270
360			3	330	300	290	270
392	1	1	2	390	370	350	330
424		2	2	390	370	350	330
452		1	3	390	370	350	330
480			4	390	370	350	330
512	1	1	3	460	410	390	380
544		2	3	460	410	390	380
572		1	4	460	410	390	380
600			5	460	410	390	380
632	1	1	4	500	460	440	420
660	1		5	500	460	440	420
692		1	5	500	460	440	420
720			6	500	460	440	420
752	1	1	5	550	500	470	460
784		2	5	550	500	470	460
812		1	6	550	500	470	460
840			7	550	500	470	460
872	1	1	6	600	540	510	490
900	1		7	600	540	510	490
932		1	7	600	540	510	490
960			8	600	540	510	490

Assumptions: Trega-cap on flue outlet, cross-cap on air intake.

In case of open outlet or diffuser pressures will be better.

Tinside, Toutside= + 20C, O2= 4,7%, Trg=50C.

## 7.5.2 Collective flue gas outlet over-pressure



An installation with a collective flue gas outlet over-pressure in combination with individually controlled boilers (e.g. 0-10 V control), where no bus cable AX00600U is connected, is NOT allowed.

Diameter and venting lengths of the flue gas outlet/air supply:

- Open system with over-pressure.

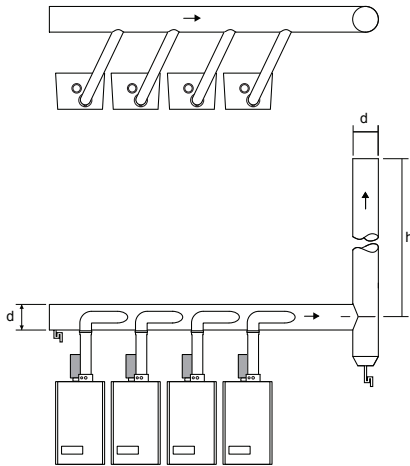

**NOTE!**

1. IPX0D at flue category B<sub>23</sub> and B<sub>33</sub>
2. Only with bus cable AX00600U connected!
3. Adjust parameter 102 to 2

Dimensions cascade flue ATAG XL Open system, overpressure, parallel							
Output (P) kW at 80/60°C	Type XL			d = minimum diameter Ø in mm			
	70	110	140	h = 2 - 5	h = 6 - 10	h = 11 - 15	h = 16 - 20
152	1	1		100	100	110	110
180	1		1	120	120	130	130
212		1	1	120	130	130	150
240			2	120	130	150	150
272	1	1	1	150	150	180	180
300	1		2	150	180	180	180
332		1	2	180	180	180	180
360			3	180	180	180	180
392	1	1	2	180	180	180	200
424		2	2	200	200	200	220
452		1	3	200	220	220	220
480			4	200	220	220	220
512	1	1	3	200	220	220	220
544		2	3	220	230	230	230
572		1	4	230	230	250	250
600			5	230	230	250	250
632	1	1	4	230	230	250	250
660	1		5	250	250	250	250
692		1	5	260	260	260	260
720			6	280	280	280	280
752	1	1	5	280	280	280	280
784		2	5	280	280	280	280
812		1	6	280	280	280	280
840			7	280	280	280	280
872	1	1	6	280	280	280	280
900	1		7	280	280	280	300
932		1	7	300	300	300	300
960			8	300	300	300	300

Pa = 50Pa

Table 7.5.2.a

Diameter and venting lengths of the flue gas outlet/air supply:

- Closed system with over-pressure.

Please contact ATAG Heating Ltd.

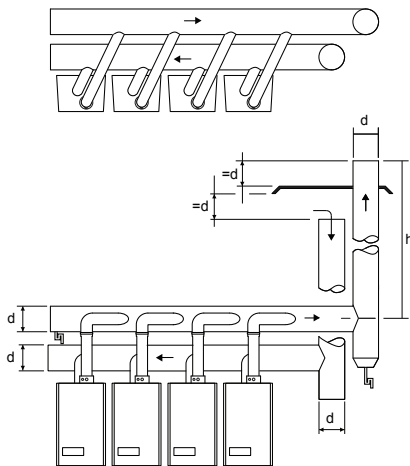

## 7.6 Condensate vent collective flue gas outlet system

Flue gases condensate inside the outlet system. Anticipate approx. 1 litre of condensate per m<sup>3</sup> of natural gas spent on heating. The resulting condensate has to be drained.

Therefore, collective flue gas outlet systems have to be fitted with a condensate drainage facility. Using a plastic siphon, the drainage is connected to the sewage system by means of an open connection. The diameter of the condensate drainage is 40 mm and may be made of PVC.

The condensate drainage of the flue gas vent system may be combined with the boilers' condensate pipe work headers.



**Draining condensate water on the rainwater drainage is not allowed due to the risk of freezing.**

## 8 Electrical connections

The appliance complies with the CE Machinery Directive 89/392/EEC. The EC Low Voltage Directive 72/23/EEC and the EC EMC Directive 89/336/EEC.

- A 230V -50Hz mains electrical supply is required fused externally at 5A.
- A deviation on the grid of 230V (+10% or -15%) and 50Hz

The installation must continue to comply with:

**United Kingdom:**

- the national rules for electrical installations, IEE regulations.

**Ireland:**

- the ECTI national rules for electrical installations

The following additional regulations also apply:

- The boiler's wiring is not allowed to be changed;
- All connections have to be made to the terminal block.

The boiler has 4 socket blocks for all electrical connections.

1. High voltage supply (230V)
2. Voltage free switches (230V relays)
3. Low voltage sensors
4. Communication bus for cascaded XL boilers

Front view

Side view

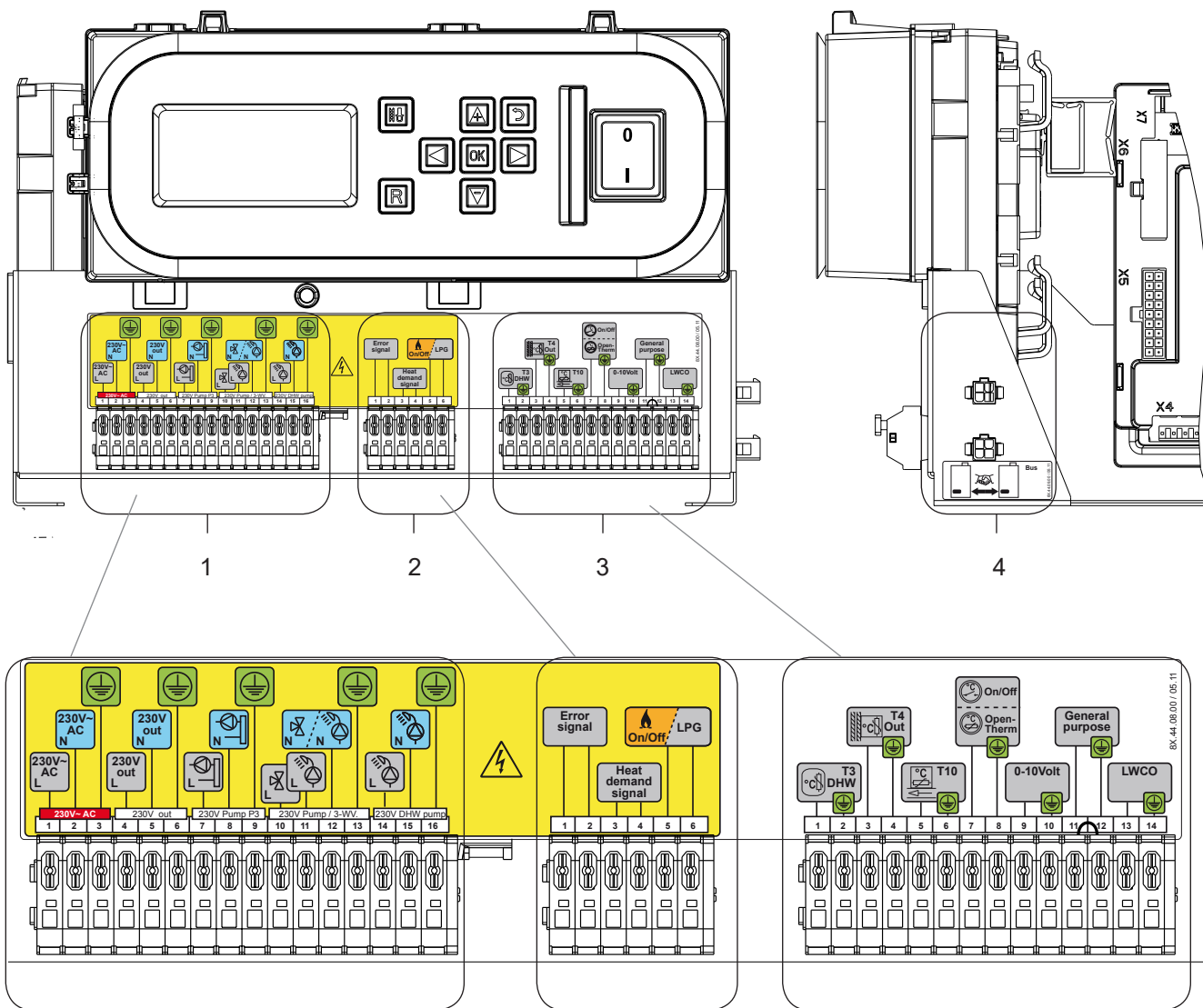

figure 7.a

1. High voltage supply: 16 Connections

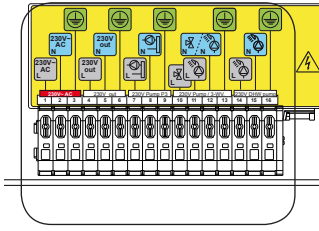

figure 8.b

Position	Connection	Application	PG	Max. V/A
1, 2, 3	Live Neutral Earth	Power for boiler. Power cable not supplied	13,5*	230V
4, 5, 6	Live Neutral Earth	Output	13,5	230V 4A
7, 8, 9	Live Neutral Earth	System pump P3	13,5	
10	Live	Three-way valve CH (closed)	13,5	
11	Live	Three-way valve (open) or DHW pump P2		
12	Neutral	Three-way valve or DHW pump P2	13,5	
13	Earth	Three-way valve or DHW pump P2		
14	Live	DHW load pump P4	13,5	
15	Neutral	DHW load pump P4		
16	Earth	DHW load pump P4		

2. High voltage switches: 6 Connections

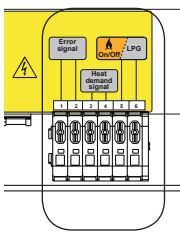

figure 8.c

Position	Connection	Application	PG	Max. V/A
1, 2	1 2	Relay output fault signal	13,5	230V 5A
3, 4	3 4	Relay output heat demand	13,5	230V 5A
5, 6	5 6	Relay output external heat source / 2nd propane gas valve	13,5	230V 5A

3. Low voltage sensors: 14 Connections

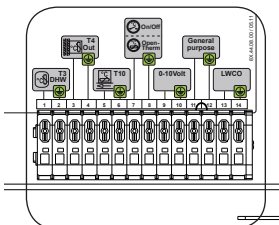

figure 8.d

Position	Connection	Application	Tulles
1, 2	1 2	Hot water sensor T3	IP67
3, 4	3 4	Outdoor sensor T4 (advice)	IP67
5, 6	5 6	Common flow sensor T10** (must be connected)	IP67
7, 8	7 8	On-Off contact** / Open Therm contact (auto detect)	IP67
9, 10	9 10	0 -10 Volt input (temperature or load)	IP67
11, 12	11 12	Blocking contact (bridge mounted)	IP67
13, 14	13 14	Low water pressure switch off contact NO (function not active)	IP67

**\*\* If an outdoor sensor is NOT connected T-day is the maximum flow temperature. Go to Timeprog. options/timeprog. CH/T-day (see page 41-43)**

\* PG glands for cable duct already assembled in the factory. For a few connections, some PG glands are supplied separately.

The maximum cable diameter for the terminals is 2.5mm<sup>2</sup>  
Connect the cable by pushing down the control on the terminal strip using a flat screwdriver (refer to fig. 8.e).

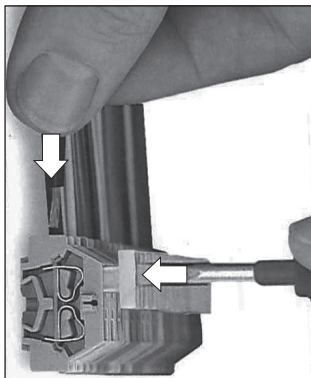

figure 8.e

4. Bus communication: 2-pole connector

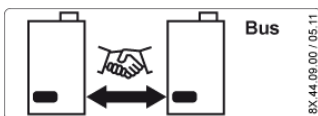

figure 8.f

Position	Connection	Application	PG
		Bus communication cable	IP67

The AX00600U bus communication cable mutually connects the cascaded boilers by 4-pole connectors on the side of the connection terminals (2 boilers: 1 cable, 3 boilers: 2 cables etc.) and is fitted with 2 IP67 tulles. A maximum of 8 boilers can be connected by this cable.

## 8.1 External controls



**NOTE:**

- T10 common flow sensor (supplied) must be connected
- T4 outside sensor (optional) is advised to be connected.

The ATAG XL provides many possibilities to operate the boilers from external controls.



**Only 1 type of control can be connected. Connections of the external control must be done in the master boiler (address 01) on terminal 3 and appropriate connections.**

Below you will find a description of the possibilities and parameter adjustments to take account of.

### 1. On-Off contact

An On-Off contact is a volt-free switch to create a heat demand with closed contact.

The On-Off control must be connected to terminal 3, position 7 and 8. This is also the connection for an OpenTherm-control, but it is self-detecting. No specific adjustments are necessary. See chapter 9.4 to adjust the flow temperature.

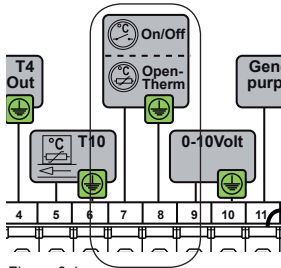

Figure 8.1.a

### 2. OpenTherm-control

An OpenTherm-control is a digital controller which is communicating with the boiler according to the OpenTherm-protocol. The controller calculates continuously the desired flow water temperature and sends this to the boiler(s). ATAG supplies the MadZ zone controller (AG1MZ05U).

The OpenTherm-control must be connected to terminal 3, position 7 and 8. This is also the connection for an On-Off contact, but it is self-detecting.

After connecting an OpenTherm-control P230 will be visible (Setting level, Param. Chapter, Cascade Param.) where the maximum set point CH can be adjusted.

For control option 1 and 2 counts that the boiler controls its own output (modulating) to achieve the desired temperature. When this is achieved the boiler modulates back to maintain the desired temperature and prevents over shoot.

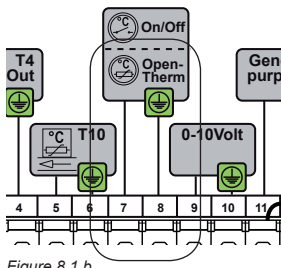

Figure 8.1.b



**If an OpenTherm controller of another brand than ATAG is used, it must be ensured that for certain error messages the heat demand is not omitted. This can result in complete loss of heat production.**

#### OpenTherm error messages

The coding of the transmitted Error Messages on a OpenTherm controller is displayed as follows:

(E) EB (E = Error Code = B and boiler number)

example: Error Code Ex02SC02 on boiler 6 will appear as (0) 26

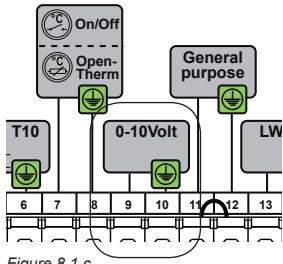

Figure 8.1.c

### 3. 0-10 Volt-control

At a heat demand of the 0-10 Volt controller a signal is sent out and varies from 0-10 Volt. This signal is translated by the ATAG XL to a set value (desired flow water temperature or load) which is sent via the ATAG data bus to the boiler(s). Depending on the Voltage the set value becomes higher or lower.

The 0-10 Volt-controller must be connected to terminal 3, position 9 and 10.

The choice for temperature or load control can be done by a parameter setting.

Go to Setting level and Param. Chapter, then to Cascade Param. and select P101.

When P101 is adjusted to 1 the **load control** is set. On that moment P205 until P210 in

chapter Cascade Param. is released and can be adjusted according to specific requests.

When P101 is adjusted to 2 the **temperature control** is set. On that moment P215 until

P220 in chapter Cascade Param. is released and can be adjusted according to specific requests.

See chapter 11 for the adjustment possibilities.

See chapter 11 for the adjustment possibilities.

**ADVICE: Choose temperature control for a more balanced boiler control**

#### Behaviour of connected external controls

- When using an OpenTherm or 0-10Volt control and a clock program is selected, the clock program of the XL will be ignored.
- When an on/off control is connected and the thermostat is switched on manually before the pre-set switch-on time, the clock program will be ignored and will run on the set day temperature. When switching off manually the clock program will be followed.

## 8.2 Wiring diagram

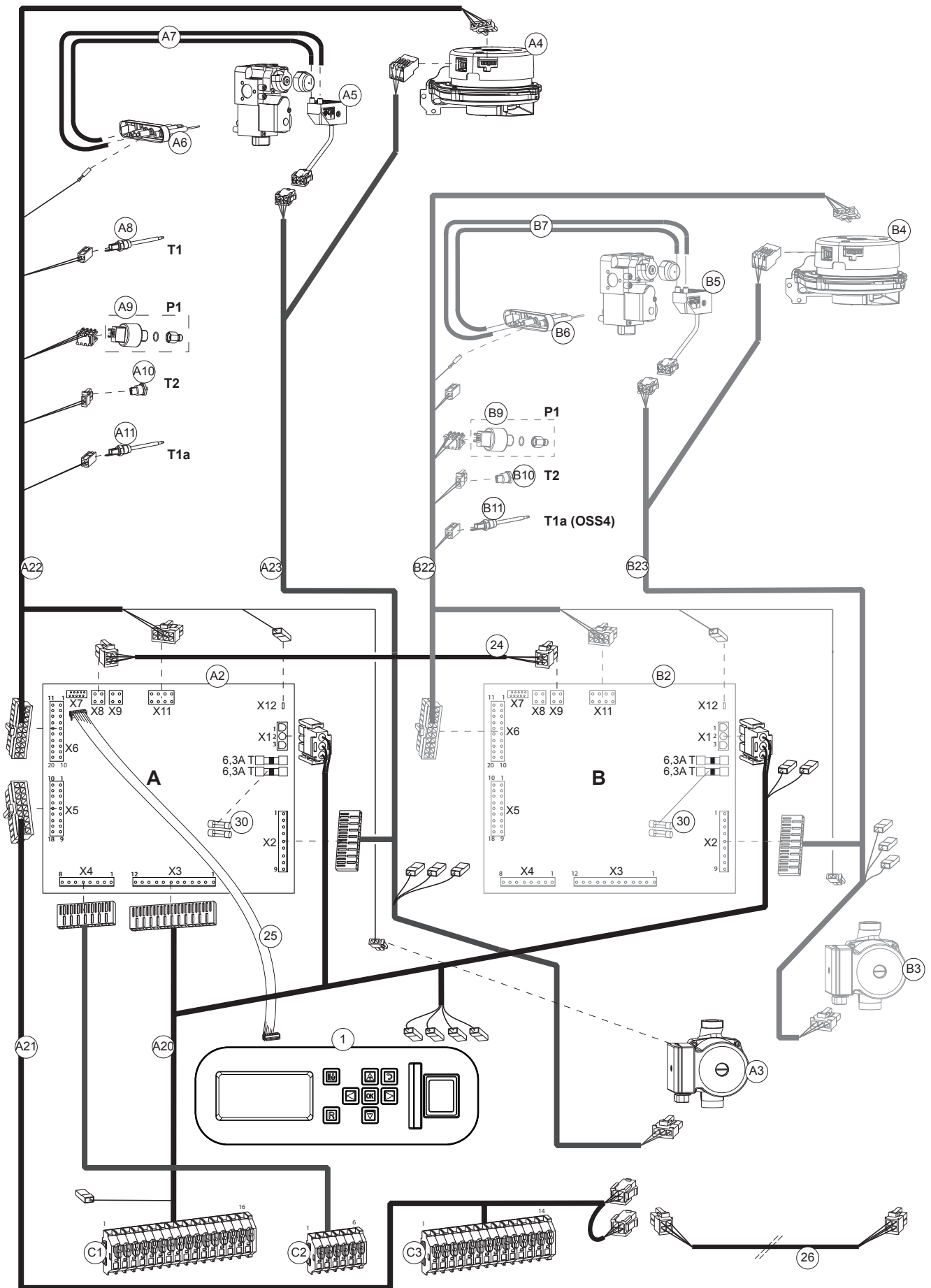

figure 8.1.a



Connections		
Item	Art.nr.	Description
Main components		
1		Control unit with screen
Burner A		
A2		Control unit
A3		Circulation pump
A4		Fan
A5		Ignition unit on gas block
A6		Ignition electrode
A7		Ignition cables
A8		Flow sensor T1
A9		Water pressure sensor P1
A10		Return sensor T2
A11		Flow sensor T1a
Burner B		
B2		Control unit
B3		Circulation pump
B4		Fan
B5		Ignition unit on gas block
B6		Ignition electrode
B7		Ignition cables
B8		Flow sensor T1
B9		Water pressure sensor P1
B10		Return sensor T2
B11		Flow sensor T1a (only OSS4)

Item	Art.nr.	Description	Conn.	Conn.	Cont.
64990289		Cable loom complete			
A20		Cable loom conn.terminal 230V+VF	Conn. C1		
1 Main switch L					
2 Main switch N					
3 Earth					
4 X1-A en X1-B, X4, 3, 1, L'					
5 X1-A en X1-B, 2, N'					
6 Earth "leeg"					
7 C1 3, 9					
8 X4 2					
9 Main switch N'					
10 C1 6, 13					
11 X3 8					
12 X3 6					
13 X3 7					
14 C1 9, 16					
15 X3 2					
16 X3 1					
17 C1 13					
18 X1-A en X1-B, Earth 1					
Conn. C2					
1 X4 3					
2 X4 4					
3 X4 5					
4 X4 6					
5 X4 7					
6 X4 8					
A21		Cable loom conn.terminal LV	Conn. C3		
1 X5 1					
2 C3 4					
3 X5 2					
4 C3 2, 6					
5 X5 5					
6 C3 4, 8					
7 X5 12					
8 C3 6, 10					
9 X5 16					
10 C3 8, 12					
11 X5 11					
12 C3 10, 14					
13 X5 14					
14 C3 12					
15 X5 15					
X5					
1 C3 1					
2 C3 3					
5 C3 5					
8 Bus1 1					
9 Bus1 2					
11 C3 11					
12 C3 7					
14 C3 13					
15 C3 14					
16 C3 9					
17 Bus1 3					
18 Bus1 4					

Item	Art.nr.	Description	Conn.	Conn.	Cont.
A22		Cable loom LV burner A	X6		
1 T1 1					
2 T2 1					
3 T1a 1					
5 P1 1					
6 P1 3					
7 Fan pwm 4					
8 Fan pwm 2					
9 X6 19					
11 T1 2					
12 T2 2					
13 T1a 2					
15 P1 2					
17 Fan pwm 5					
18 Fan pwm 1					
19 X6 9					
X11					
3 Pump pwm 1					
7 Pump pwm 2					
X12					
Ionisation					
B22		Cable loom LV burner B	See A22		
A23		Cable loom 230V burner A	X2		
1 Fan 230V 3					
2 Fan 230V 2					
3 Fan 230V 1					
4 Ignition and Gasvalve 1					
5 Ignition and Gasvalve 4					
6 Ignition and Gasvalve 2					
7 Pump 230V 3					
8 Pump 230V 2					
9 Pump 230V 1					
10 Ignition and Gasvalve 3					
11 Ignition and Gasvalve 6					
B23		Cable loom 230V burner B	See A23		
24		Cable loom bus Burner A-B	X8-A	X8-B	
1 X9 1					
2 X9 2					
3 X9 3					
4 X9 4					
25	64990293	Flat cable MMI			
26	3905043	Communication bus cable			

## 9 Boiler control

The boiler has a pilot-control. This control takes care of most of the manual settings but also provides numerous settings to adjust the control exactly to the installation and user requirements.

### Display

The LCD screen is backlit. The light is activated by pushing one of the buttons.







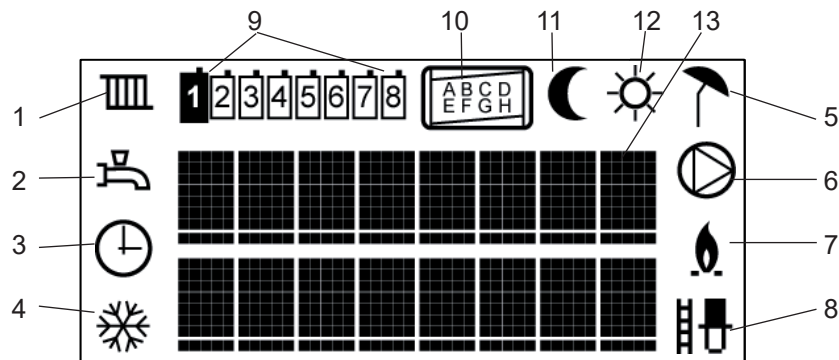

There are 3 light colours available. The various colours indicate the following:

Blue	Basic level
Green	Setting level
Red	Problem display (flashing)

Having pressed a button, the screen light stays on for 2 minutes (blue screen) or 20 minutes (green screen).

Screen explanation



-  1. CH-program active
-  2. DHW-program active
-  3. Clock program active
-  4. Pump continuously active or pumps active during frost protection
-  5. Boiler off at outside temperature > T-day (when day temperature is active)  
or > T-night (when night temperature is active)
-  6. System pump on
-  7. Burner on. Starts flashing during heat demand, continuous when burner is on
-  8. Chimney sweep function (100% power for emission measurement)



- 9. Boiler address:  
1 = Cascade Master  
2.8 = Cascade Slaves



- 10. Identification burner inside boiler



- 11. Night temperature active



- 12. Day temperature active

- 13. 2 text lines with 8 characters each

*Boiler symbols are not visible in case of a single boiler or when no bus communication cable is connected (Error code M024sc08).*

## 9.1 Operational status

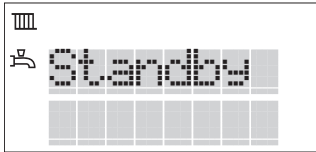

- <b>Standby</b>	Standby. Boiler is ready for operation.
- <b>Vent.Phase</b>	Ventilation stage
- <b>Ignition phase</b>	Ignition stage
- <b>Burner lit CH</b>	Burner active for heating
- <b>Burner lit DHW</b>	Burner active for hot water
- <b>CH T &gt; Tset</b>	Burner off on account of too high flow temperature CH
- <b>Overrun CH</b>	Overrun time pump over CH
- <b>Overrun DHW</b>	Overrun time pump over DHW
- <b>Service</b>	Boiler needs maintenance. Contact installer
- <b>Frost</b>	Burner active for frost protection

## 9.2 Operation

The keyboard consists of a logical button allocation for menu control, confirmation, and correction and emission measurement.

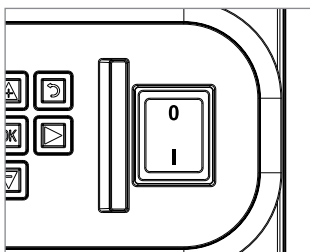
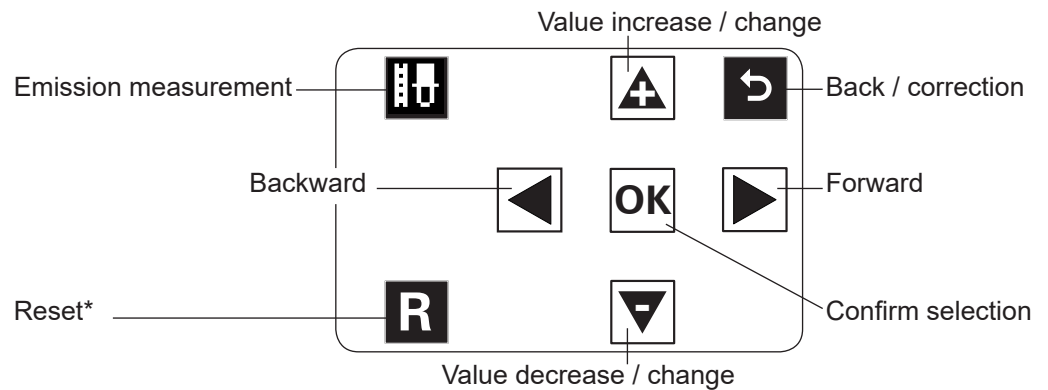

\* Reset only functions in case of an Error or Message. If reset is rapidly pressed over a short period of time, the device will block completely. Only loss of power (unplug) will restart the device completely. Recommendation: First identify the fault by finding the fault code in the fault-code list in the problem-shooting chapter and solve the problem.

The main switch is located on the right hand side of the keyboard. This switch controls the 230V power supply (L and N).

## 9.3 Commissioning

Turn the electrical supply on (heating system does not have to be filled);

During start-up, a blue screen is displayed:

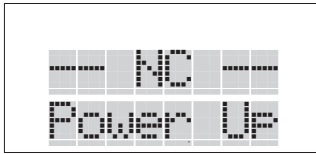

NC Power Up (= start-up screen)

Please wait (under certain circumstances)

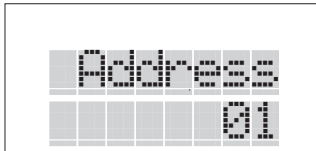

Then you see: Address 01 (= allocation of boiler address)

In the case of a cascade installation: Select the correct address and press OK  
Select for the first boiler 01 (=Master), for the next 02, 03 etc (=Slave)

The address can be changed by pushing the + button (increase value) and the – button (decrease value). Once the + or – buttons has been pushed, the value starts flashing.

In the case of a single boiler: Confirm address 01 by OK

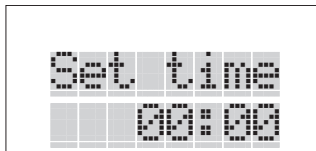

The display shows: Time Set 00:00 (= setting actual time)

Setting time and day is only required on the Master-boiler. The Slave-boiler will take the time and day settings automatically.

First set the hours using + and -.

Press the "right arrow" button to move to the minutes.

Set the minutes using + and -.

Confirm by OK

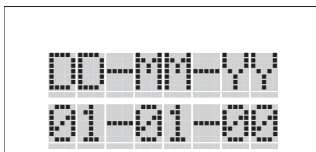

The display shows: DD-MM-YY 01-01-00 (= setting actual date)

Change the settings using the + and – button. Jump from DD to MM and YY using the arrow button.

After confirmation by OK and after the automatic de-aeration programm has ended, you will see the standard read-out "Good" showing the date and the time after the de-aerating program.

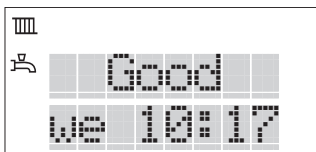

Standard read-out: Good we 10:17

Good indicates that the boiler operates normally (burner on or off)

wo 10:17 indicates the actual day and time.

Following a restart (after loss of power):

Following a brief loss of power, the control will start-up as described above, but all settings are retained.

In the case of a loss of power lasting more than 2 hours the time and date has to be set again. All other settings are retained.

If the water pressure is below 1.0 bar, the screen will show: FILL. Please refer to the chapter Filling CH-system.

**The standard read-out offers 3 information screens.**

Switching to different screen scan be found using the + or - button

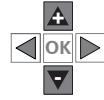

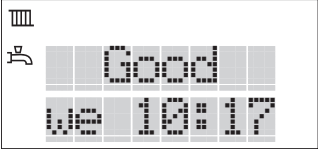
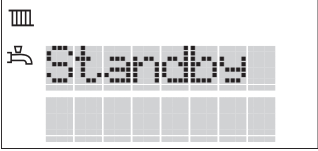
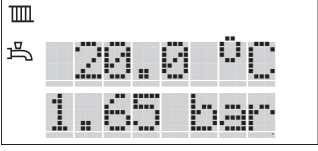
- |  |   |
|--|---|
| <p>1</p>  | 1. "Good"- read-out      Good with actual day and time (see above)                                  |
| <p>2</p>  | 2. Operational status      Refer to chapter 9.1 for explanation of texts                            |
| <p>3</p>  | 3. Technical read-out      Actual water flow temperature. (T1 in °C) and water pressure (P in bar). |

**For XL boilers in cascade**

For XL boilers in cascade, the bus communication cables between the boilers must be connected (see section electrical connections).

The master-boiler (address 01) should be set to how many boilers are actually connected.

From the standard display with illuminated display:

1. Press 2 seconds the arrow buttons simultaneously;
2. Use the right arrow button until: Param Mode;
3. Press the OK button; *Cascade param. is shown*;
4. Press the OK button again;
5. Push the right arrow button until P114;
6. Press the OK button;
7. Press the + button until the total number of boilers in cascade:
8. Press the OK button;
9. Press the return button until standard read-out

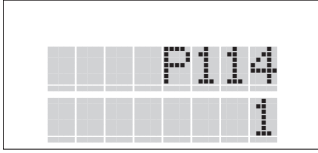
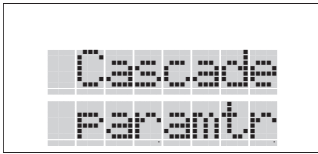
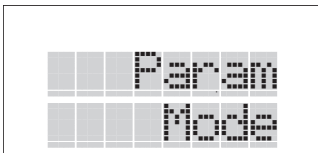

**Switching on the Heating, DHW and Pump program**

By switching on the functions (  ,  and/or  ) the boiler is turned on.

Proceed as follows:

From the standard display with illuminated display:

1. Press the right arrow button:  
The display shows: Basic settings;
2. Press the OK button;
3. Press the right arrow button:  
The display shows: CH prog off;
4. Press the + button:  
The display shows: CH prog on;
5. Press the OK button;
6. Repeat the procedure from point 3.  
In this way the functions DHW and Pump can be switched on.
7. Press the return button to go back to the standard display.

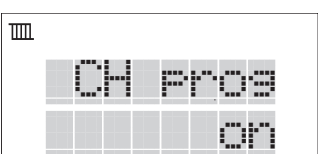
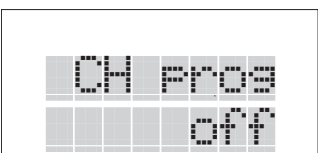
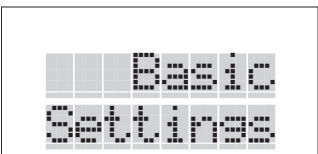

Depending which programs are switched on the corresponding symbols will be shown.

## 9.4 Setting the maximum flow water temperature with On/Off-control

P101 = 0

**Setting the maximum flow water temperature with connected outdoor sensor T4**  
(starting with illuminated display):

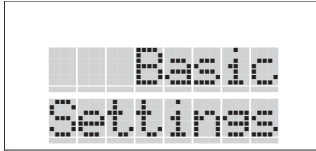

1. Press the right arrow button:  
The display shows: Basic Settings;
2. Press the OK button;

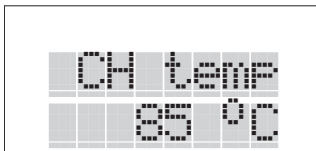

3. Press the right arrow button until CH temp:  
The display shows: CH temp 85°C;
4. Press the + or - button to adjust the desired flow temperature and press the OK button.

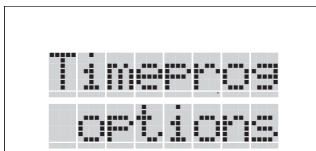

**Setting the maximum flow water temperature without outdoor sensor T4**  
(starting with illuminated display):

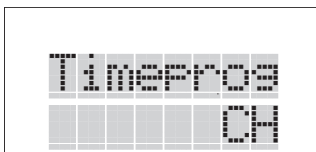

1. Press the right arrow button until Timeprog-options;
2. Press the OK button;
3. Press the right arrow button until Timeprog CH;
4. Press the OK button;

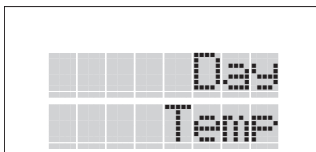

5. Press the right arrow button until Day Temp;
6. Press the OK button;  
The display shows: T\_day

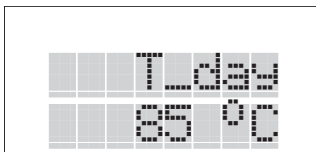

7. Press the + or - button to adjust the desired flow temperature and press the OK button.

## 9.5 Filling the heating system

When all boilers have been electrically commissioned as described above, then the heating system can be filled. Each boiler is fitted with a filling and drain valve. The filling hose from the water tap is then connected to it.



**Fill the heating system only with drinking water. Refer to the Water Quality chapter for quality requirements of the filling water.**

### Water pressure

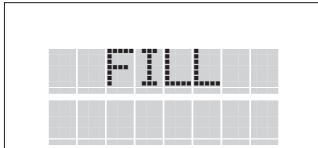

Screen display			Description	Action
Good Read-out	Operation status	Technical read-out		
<b>FILL</b> dd 00:00	FILL Bx12sc03	xx.x°C P0,0	Water pressure is 0 bar, boiler off	Top up water
<b>FILL</b> dd 00:00	FILL Bx12sc03	xx.x°C P≥0,7	Water pressure above 0.7 bar. The boiler is off. The automatic venting program starts	Top up water until approx. 1,7 bar
<b>Block.</b> dd 00:00	Vent Prog.	xx.x°C P≥1,2	Automatic venting program, afterwards (approx. 13 min.) boiler is on standby	Top up water until approx. 1,7 bar
Good dd 00:00	(variable)	xx.x°C P>1,0 <4,0	Water pressure is good. Boiler standby or in normal operation	None
<b>Block.</b> dd 00:00		xx.x°C P≥4,0	Water pressure too high, boiler off due to blocking	Drain water until approx. 1,7 bar
Good dd 00:00	(variable)	xx.x°C P<3,7	Water pressure is good. Boiler operates normally again	None
<b>Message/Block.</b> dd 00:00	FILL Message Mx24sc14	xx.x°C P<1 >0,7	Water pressure too low. Boiler is limited to 50% load	Top up water until approx. 1,7 bar

### Venting program

When, on filling the system, the water pressure rises above 0.7 bar, the venting program will start automatically. The program lasts approx. 13 minutes and in doing so, turns the pump on and off and, if fitted, the three-way valve every 80 seconds to remove the remaining air from the boiler. All venting points still have to be vented when filling the installation. The boiler will be on standby after the venting program.



**The automatic venting program only vents the boiler and not the rest of the installation.**

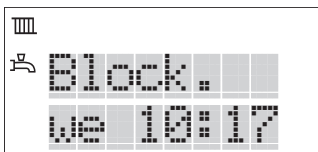

Read-out 1 (Good status) displays Block. with actual day and time on the screen.

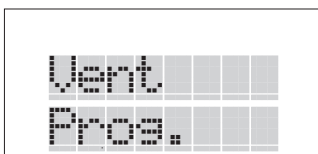

Read-out 2 (operational status) displays Vent Prog on the screen. [From Good press the – button 1x: Vent Prog is now displayed]

Interrupting the venting program (not recommended) is only possible from the setting level by pressing OK during the venting program.

For boiler checks please refer to the chapter Checks prior to commissioning. For any checks or setting changes, refer to the Basic Settings chapter.

## Menu structure

There are 2 setting levels

1. Basic level (manager/user)      Blue screen
2. Setting level (Installer):      Green screen



**With the illumination switched off, first press on one of the buttons to switch the illumination on and then continue with the setting. Having pressed the last button, the blue illumination will switch off after 2 min.**

## Menu structure at Basic level

Good				
Operational status	Basic setting	Timeprog. options	Param Mode	Info
Tech. Read-out	OK	OK	OK	OK
▶ CH prog	▶ Set Date and time	▶ Boiler param	▶ Cascade	
▶ DHW prog	▶ Timeprog. CH	↩	▶ Other	
▶ Pump prg.	▶ Timepr. DHW		↩	
▶ Timepr. CH	↩			
▶ Timep. DHW				
▶ CH temp				
▶ DHW temp				
▶ Units				
▶ Language				
▶ Restore Defaults				
↩				

◀▶ With the arrow buttons you can go through the different chapters.

OK Press OK to select or to confirm a change.

▲ ▼ With the + and - button you can increase or decrease a selected value.

↩ Back to previous screen or standard read out. Press this 'return-button'.

*Remark: Depending which parameter settings are set, some options will not be displayed.*

Refer to the Parameters chapter for all parameters and related settings.

### Clock program (from standard switched off in Basic settings)

The switch times in the pre-set clock programs are detailed in the table on the right. Each clock program can be adjusted to each individual situation. Conditions are:

- Maximum 4 switch points per day;
- Settings for day and night are determined by the settings: Time pr. options/Time prog. CH/Day Temp. and Night temp.;
- The setting OFF switches the heating off during the whole set period. The frost protection is active;
- Setting - - - turns the switch point OFF;
- Switch times can be set in steps of 30 minutes.

#### Advice:

Keep in mind when setting the switching periods for domestic hot water that it is sufficiently long to ensure that hot water is always available during actual use. In most cases, the pre-set program 1 of the clock program suffices.

#### Behavior of connected external controls

- When using an OpenTherm or 0-10Volt control and a clock program is selected, the clock program of the XL will be ignored.
- When an on/off control is connected and the thermostat is switched on manually before the pre-set switch-on time, the clock program will be ignored and will run on the set day temperature. When switching off manually the clock program will be followed.

Pre-set clock programs							
Day	Switch point	CH pre-set 1		CH pre-set 2		DHW pre-set 1*	
		Time	Setting	Time	Setting	Time	Setting
<small>4 switch points per day, adjustable per 30 min.</small>							
mo	1	7:00	day	8:00	day	3:00	on
	2	18:00	night	12:00	night		
	3			17:00	day		
	4			19:00	night		
tu	1	7:00	day	8:00	day		
	2	18:00	night	12:00	night		
	3			17:00	day		
	4			19:00	night		
we	1	7:00	day	8:00	day		
	2	18:00	night	12:00	night		
	3			17:00	day		
	4			19:00	night		
th	1	7:00	day	8:00	day		
	2	18:00	night	12:00	night		
	3			17:00	day		
	4			22:00	night		
fr	1	7:00	day	8:00	day		
	2	18:00	night	12:00	night		
	3			17:00	day		
	4			19:00	night		
sa	1			8:00	day		
	2			12:00	night		
	3			17:00	day		
	4			19:00	night		
su	1					3:00	on
	2						
	3						
	4						

\* The clock program for domestic hot water is set on continuous demand to prevent there being no hot water available at starting up. The program can be adjusted to each individual situation.



## Menu structure at Setting level

With the illumination switched off, first press on one of the buttons to switch the illumination on and then continue with the setting. Having pressed the last button, the green illumination will switch off after 2 min.

From the standard read-out, keep both arrow buttons pushed down simultaneously for 2 sec. The screen color will change from blue to green.

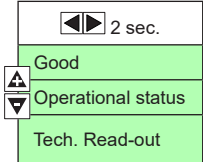
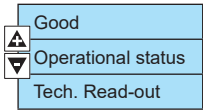

With the arrow buttons you can go through the different chapters.  
 Press OK to select or to confirm a change.  
 With the + and - button you can increase or decrease a selected value.  
 Back to previous screen or standard read out: Press this 'return-button'.

	Basic setting	Timeprog. options	Param Mode	Service Mode	Error	Info
	CH prog	Set Date and time	Cascade param	Throttle	Error Burner A	Cascade
	DHW prog	Timeprog. CH	Boiler param	Airflush	Error 01	Boiler
	Pump prg	Timeprog. DHW	Burner A Param	Pump speed	Error 02	Burners
	Timepr. CH		Burner B Param	3-way valve	...	Other
	Timep. DHW			Pump P2	Error 10	
	CH temp			Pump P3		
	DHW temp			Pump P4	Error Burner B	
	Units			LPG		
	Language			Fault		
	Restore Defaults			Heat demand		
				Boiler address		
				Reset Counters		

Remark: Depending which parameter settings are set, some options will not be displayed.

Refer to the Parameters chapter for all parameters and related settings.

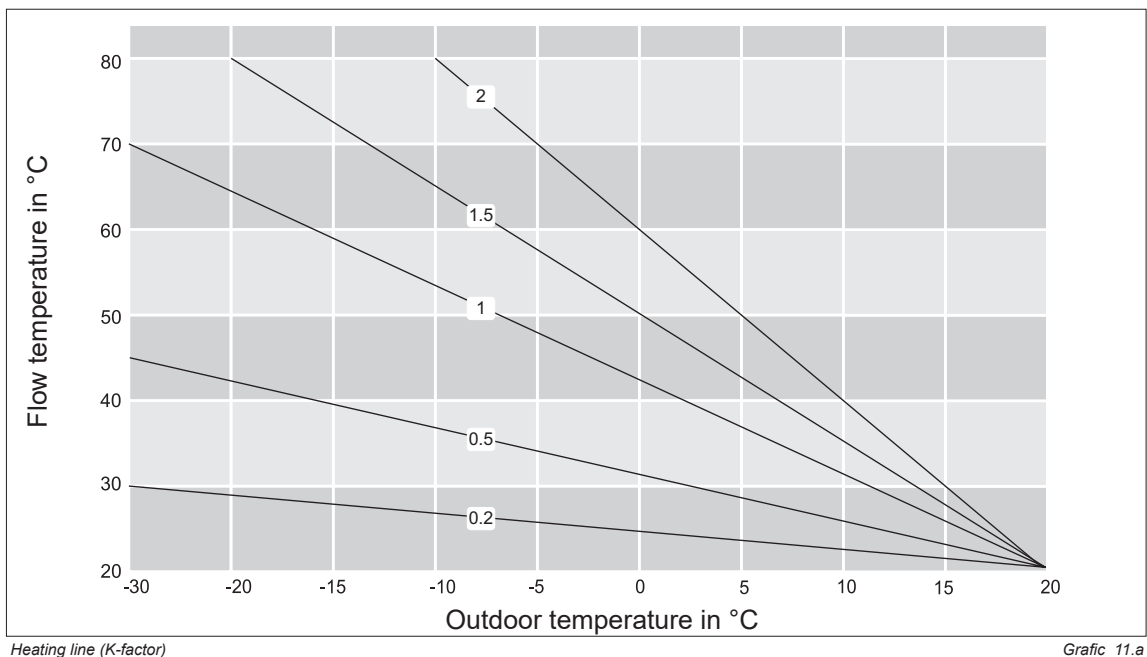

# 11 Parameters

For operation and menu overview, refer to chapter Boiler control and Basic settings.

Basic settings		Basic settings	
PARA	factory setting	Description	Range
CH prog	off	CH-program	on/off
DHW prog	off	DHW-program	on/off
Pump prg	off	Pump program (frost protection)	on/off
Timerpr CH	off	Clock program CH	on/off
Timerp DHW	off	Clock program DHW	on/off
CH temp	85	Adjusted maximum flow temperature in °C (only active with connected outdoor sensor & P101=0)	10-90
DHW temp	65	Adjusted maximum DHW temperature in °C (only visible when P100>0 and T3 is connected)	10-80
Units	SI	Selection possibility units SI=Europe, Imp(erial)= USA	SI/Imp
Language	GB	Language selection	GB, NL, I, D, F, PL, TR, RUS, UA
Restore defaults		Reset of the factory settings (dependant of selected level)	
Timeprog options		Clock program options	
PARA	factory setting	Description	Range
<b>Set date and time</b>			
Set Time	00:00	Actual time setting in hours and minutes	
Set Date	DD-MM-YY	Actual date setting day-month-year	
Daylight saving	Europe	Zone for daylight saving	Off-Eur-USA
	12/24hrs	12-hour (AM/PM) or 24-hour display	AM/PM-24h.
Date format	DD-MM-YY	Reproduction of date display (DD-MM-YY, MM-DD-YY, YY-MM-DD)	
<b>Time prog CH (only visible when NOT OpenTherm or 0-10V)</b>			
Day temp	T-day 20	Day temperature according heating line in °C (if outdoor sensor is NOT connected: max flow temp.)	10-30 (10-90)
Night temp	T-night 15	Night temperature according heating line (Eco) in °C	10-30
Select Preset	Preset 1	Choice for the preselected time programm CH	1 or 2
Adjust Timeprog	mo1 off 03:00	See table time programs CH It is possible to select 4 switch moments (steps of 30 min.) per day. Choice: day temperature, night temperature, off, - - - Copy function to next day: after switch moment 4.	
Store Preset		Store of the adjusted time program for CH	
<b>Timepr DHW (only visible when NOT OpenTherm)</b>			
Select Preset	Preset 1	Choice for the preselected time programm DHW	1 or 2
Adjust Timeprog	mo1 off 03:00	See table time programs DHW It is possible to select 4 switch moments (steps of 30 min.) per day. Choice: on, off, - - - Copy function to next day: after switch moment 4.	
Store Preset		Store of the adjusted time program for DW	

Param Mode	Parameter chapter			
PARA	factory setting	Description		Range
<b>Cascade param.</b>		<b>Cascade parameters</b>		
P100	0	Domestic hot water facility 0: no DHW 1: Solo boiler with 3-way valve 2: n.a. 3: Solo boiler with cylinder loading pump P4 and 3-way valve 4: n.a. 5: After low loss header: DHW after LLH with cylinder pump P2 and P3=off 6: After low loss header: DHW after LLH with cylinder pump P2 and P3=on at heat demand CH 7: After low loss header: DHW loading system after LLH with cylinder loading pump P2, P4 and P3=off 8: After low loss header: DHW loading system after LLH with cylinder loading pump P2, P4 and P3=on at heat demand CH	NOTE: Option 6 and 8 not for Low Temperature systems, unless separately controlled	0-8
P101	0	Heating 0: 0+10V not active 1: 0+10V= load control (see further P205 until 210) 2: 0+10V= temperature control (see further P215 until 220) 3: Showroom position	ADVICE for using 0-10V: Choose option 2 for a balanced behaviour of boiler control.	0-3
P104	0	Outside sensor T4 0: autodetect 1: connected		0-1
P105	0	Common flow sensor T10 0: autodetect 1: connected		0-1
P106	20	Min. Setpoint T10		0-60
P107	0	Min.Setpoint function T10 0: off 1: minimum value setpoint at heat demand CH 2: continuously minimum value setpoint		0-2
P109	0	Correction outside sensor		-5 - 5
P111	20	CH-set gradient-reference		0-60
P112	1,0	CH-set gradient in °C/10sec in steps of 0,1°C		0-10
P114	1	Number of boilers in cascade (To be set manually!)		1-8
P121	1	Relay function Propane/External heating source 0: Only propane 1: On/Off external heating source		0-1
P125	1	DHW priority 0: No 1: Yes		0-1
P157	0	OpenTherm error bit selection 0: Only errors 1: Errors and blockings 2: Errors, blockings and messages		0-2
P158	0	Error relay selection 0: Only errors 1: Errors and blockings 2: Errors, blockings and messages		0-2
P170	95	Switch on moment relay external heating source When demand is higher then adjusted value the external heating source will be switched on		0-100%
P171	90	Switch off moment relay external heating source When demand is lower then adjusted value the external heating source will be switched off		0-100%
P203	2	Overrun time secondary pump P3 in minutes At P101 = 1 (Load control):		0-60
P205	2	0-10V, load voltage to have minimum heat demand (P208 power) (If P101=1)		0-10
P206	9,5	0-10V, load voltage to have maximum heat demand (P207 power) (If P101=1)		0-10
P207	100%	0-10V, load maximum power (dynamic range) (If P101=1)		0-100
P208	0%	0-10V, load maximum power (dynamic range; 0% is minimum power) (If P101=1)		0-100
P209	1	0-10V, load heat demand when input voltage> (If P101=1)		0-5
P210	0,5	0-10V, load no heat demand when input voltage< (If P101=1)		0-5
		At P101 = 2 (Temperature control):		
P215	2	0-10V, load voltage to have minimum heat demand (If P101=2)		0-10
P216	9,5	0-10V, load voltage to have maximum heat demand (If P101=2)		0-10
P217	1	0-10V, load heat demand when input voltage> (If P101=2)		0-5
P218	0,5	0-10V, load no heat demand when input voltage< (If P101=2)		0-5
P219	30	0-10V, temperature setpoint at minimum input voltage (If P101=2)		10-90
P220	85	0-10V, temperature setpoint at maximum input voltage (If P101=2)		10-90
P252	2	Slope heating line (K-factor)		0,1 - 9,9
P256	2	Hysteresis Summer/Winter in °C (if T4 was detected)		0-10
P266	2	Switch on delay at heat demand in minutes		0-10
P267	168	Boiler sequence for boilers in cascade in hours		1-255
P283	1	Frost protection 0: T10 and P3 not active 1: T10 and P3 active		0-1
P284	0	Switch on temperature frost protection in °C		-40 - 20

Boiler param		Boiler parameters	
P100	0	Domestic hot water facility (visible when boiler address is 2 - 8) 0: no DHW 1: Solo boiler with 3-way valve 2: n.a. 3: Solo boiler with cylinder loading pump P4 and 3-way valve 4: n.a.	0-4
P102	0	Cascade flue gas system 0: Flue gas system individual or collective under pressure 1: N.a. 2: Flue gas system collective over pressure 3 N.a.	0-3
P108	0	Kind of gas 0: natural gas 1: propane gas	0-1
P122	0	DHW temperature sensor T3 0: autodetect 1: connected	0-1
P123	30	Switching time 3-way valve in seconds	0-255
P125	1	DHW priority 0: No 1: Yes	0-1
P132	1	Pump continuously 1: Unit pump P1 2 Unit pump P1 and installation pump P3	1-2
P154	100%	Maximum load CH	0-100
P155	100%	Maximum load DHW	0-100
P160	100%	Maximum pump capacity (only with modulating circulation pump)	30-100
P179	1	Overrun time cylinder pump P2/P4 in minutes (if P100 > 1)	0-60
P181	5	Minimum cool down DHW temperature in °C (if P100 > 0)	0-15
P182	1	Load adjustment due to temperature fall DHW in °C/10sec. (if P100 > 0)	0-10
P183	65	DHW Anti legionella temperature (if P100<>0 and P122=1) in °C	10-80
P184	7	DHW Anti legionella service timer (if P100<>0 and P122=1) in days	1-30
P185	3:00	DHW Anti legionella time of day (if P100<>0 and P122=1)	0:00-23:50
P190	80	Flow temperature T10 at DHW in °C (using cylinder thermostat) (if P100 > 0)	10-90
P801	0%	Local altitude compensation and flue length	0-15%

BurnerA param		Burner A parameters	
		When the boiler has 2 heat exchangers Burner B will follow with the same parameters	
P953	OSS4: 65% OSS2: 80%	Minimum pwm-level pump (only with modulating pump).	43-100%

Service chapt.		Service chapters	
		Choose burner AB, A or B after selecting one of the functions using arrow buttons. Exchanger symbol will show: AB, A or B	AB-A-B
Throttle	0	Manually burner control. Press OK, then + and - button to increase/decrease the value (0=off, 1%=low load untill 100%=full load)	0-100
Airflush	0	Manually fan control Press OK, then + and - button to increase/decrease the value	0-100
Pumpspeed.	43	Minimum pump speed (only with modulating circulation pump)	43-100%
3-way valve / P2	CH	Manually control of the 3-way valve for DHW. Only for boilers with DHW via 3-way valve	CH-DHW
Pump P3	off	Manually control of the system pump P3. (Only when pump is off) When 'On' pump symbol will be displayed	on-off
Pump P4	off	Manually control of the DHW pump P4	on-off
LPG	off	Manually control of LPG valve (Volt-free)	on-off
Fault	off	Manually control of fault relay for external error signal (Volt-free)	on-off
Heat demand	off	Manually control of heat demand relay for external display heat demand (Volt-free)	on-off
Boiler on-off	off	Manually control of external heating source. On-off contact for control external heating source (not visible in case of LPG)	on-off
Boiler address		Adjusting/changing boiler address	01-08
Reset Counters		Reset of counters after maintenance interval	

Error	Errors	A-B
Error burner A	The last 10 errors with data will be stored. Choose burner A or B using arrow buttons. Exchanger symbol will show: A or B	
Error 01	Select other error number (02-10) with arrow buttons Every error contains the following info (Press + button for forward, - button for backward)	
	Code Exxscxx	
	Date	
	Time	
	Operational status	
	T1 flow temperature	
	T2 return temperature	
	T1a secondary flow temperature	
	P1 water pressure	
	P2 cylinder pump	
	P3 system pump	
	P4 cylinder load pump	
	Damper on/off (no function)	
	Fan on/off	
	Gas valve open/closed	
	Ignition on/off	

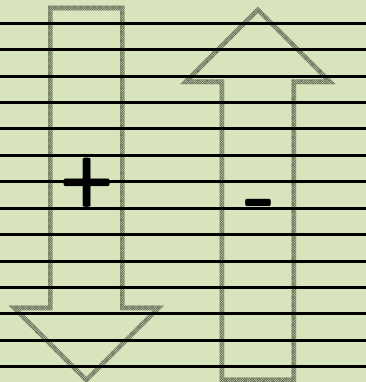

Info	Information	
<b>Cascade</b>	Information of cascade system	
T3	xx.x°C	DHW temperature T3 in external cylinder in °C (if connected and P100 is selected for DHW)
T4	xx.x°C	Outdoor temperature T4 in °C (if connected)
T10	xx.x°C	Temperature T10 sensor in low velocity header in °C
OT sp	x.x°C	OpenTherm setpoint room temperature in °C (visible when OT is selected)
Req Load	xx%	Requested load of the cascade system in %
Req Temp	xx.x°C	Actual requested flow temperature according gradient line of the cascade system in °C
Req Temp	xx.x°C	End value of the requested flow temperature of the cascade system in °C
Error	off	Status relay external error signal
0-10V	xx.xV	Tension on 0-10V contact (visible when P101=1 or 2)
P3	off	Status system pump P3
P2	off	Status DHW pump P2 (visible when P100=5-8)
P4	off	Status cylinder loading pump P4
Heatdmd.	off	Heat demand yes/no
LPG / Extra B	off	Status relay external heating source

Boiler	Information of the boiler	
T1-ave	xx.x°C	Actual average flow temperature of the boiler in °C
T2-ave	xx.x°C	Actual average return temperature of the boiler in °C
T3	xx.x°C	DHW temperature T3 in external cylinder in °C (if connected and P100 is selected for DHW)
Req Load	xx%	Requested load of the boiler in %
Req Temp	xx.x°C	Requester flow temperature of the boiler in °C
3WV	closed	Status 3-way valve
P2	off	Status DHW pump P2 (visible when P100=1-4)
P4	off	Status cylinder loading pump P4

BurnerA	Information of burner/heat exchanger A	A-B
	Select burner A or burner B using + and - button. Symbol heat exchanger will show: A or B	
T1	xx.x°C	Actual flow temperature
T1a	xx.x°C	Actual flow temperature secondary sensor
T2	xx.x°C	Actual return temperature
Req Load	xx%	Requested load in %
Flame	x.xx uA	Actual ionisation in µA
Water Pr	x.xx bar	Actual water pressure
FanSpeed	xx	Actual fan speed in revolutions per minute
Fan PWM	x.x%	Actual fan capacity in %
Fan	off	Status fan
Gas	off	Status gas valve
Ign.	off	Status ignition
P1 PWM	x.x%	Actual pump speed in % (only with modulating circulation pump)
P1	off	Status pump

Others	Select burner A or burner B using + and - button. Symbol heat exchanger will show: A or B	A-B
Stand-by	xx h	Number of hours stand by
Burn ON	xx h	Number of running hours with burner on
Service	xx h	Number of running hours to go for maintenance interval
Ignition	xx	Number of times ignition
Faults	xx	Number of times in error
Safety	02017005	
Regul.	01017016	
MMI	03017017	
OEM par.	00017xxx	xxx: 020 = XL70, 080 = XL110, 140 = XL140

## 11.1 Activate factory settings

Do the following to reactivate factory settings (any changed settings, except from P108 and P121, will be lost):

### Activating the factory settings from user level only:

From the standard blue screen display:

1. Select using the right arrow button: Basic settings;
2. Press the OK button;
3. Press the right arrow button until: Restore Defaults
4. Press OK

Screen displays: Restore OK

5. Press OK again

Screen displays: Restore Defaults

This has now restored the factory settings.

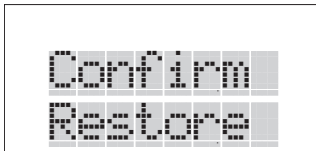
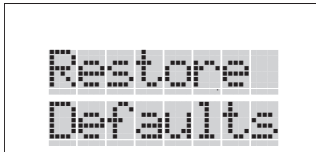



### Activating the factory settings from installer level:

From the standard blue screen display:

1. Press down the arrow buttons simultaneously for 2 seconds;
2. Continue with the same instructions from point 1 to 5 described above.

The procedure can take about 20 seconds and shows a blank screen followed by the text Please Wait.

## 12 Put out of operation

In some cases it might be necessary to put the complete boiler out of operation. The boiler is put out of operation by switching off the three functions (  ,  and/or  ).

Proceed as follows:

From the standard blue screen display:

1. Press the right arrow button:  
Screen displays: Basic setting;
2. Press OK;  
Screen displays: CH prog on;
3. Press the - button:  
Screen displays: CH prog off;
4. Press OK;
5. Repeat procedure from point 3 onward.  
This switches off the functions DHW prog and Pump prog respectively.
6. Press the return button to return to the standard display.

ATAG recommends leaving the power switch switched on to ensure that the boiler pump(s) and three-way valve (if fitted) are automatically activated to prevent them from sticking. The frost protection remains active. Leave gas supply open.



**If frost, during the period when the boiler is out of operation, is likely, then you are advised to remove the power from the boiler and drain the boiler(s) and installation. In this case: close the gas valve.**

## 13 Inspection and maintenance



**Boiler maintenance is only to be carried out by qualified staff with calibrated equipment.**

**When replacing spare parts only original ATAG Service parts are to be used. For this purpose, please refer to the Service parts list to find article numbers and exploded views. Please contact ATAG Heating UK.**

### 13.1 Maintenance intervals

Maintenance has to be carried out after 16,000 operational hours max. or every 4 years, whatever comes first.

Depending on the intensive use of the device, maintenance intervals will have to be decreased accordingly. For other situations, maintenance intervals may also have to be decreased. In such cases, please contact ATAG for additional advice.

Inspection and maintenance tasks have to be carried out in accordance with the maintenance instructions at all times. Some tasks are described in these maintenance instructions. For complete inspection and maintenance instructions, please refer to Search Help ATAG XL.



**When carrying out maintenance on the boiler, the gas tap has to be closed and secured against opening.**

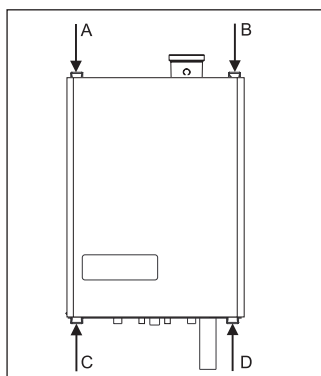

Removing housing

figure 13.1.a

The housing has to be removed in order to carry out maintenance jobs on the boiler. The housing has been secured by 4 quick-lock nuts. First, remove the screws from the quick-locks, open the quick-locks, lift up the housing from below and move it away to the front.

### 13.2 Checks prior to commissioning

Changing settings such as burner pressure and setting the amount of air is not necessary. Only in the case of failures or replacement of the gas unit, venturi and/or ventilator, does one have to check and adjust the zero-pressure control and O<sub>2</sub> percentage accordingly (Refer to Help reference).



**Following maintenance tasks always check all gas-conducting components on leakages by use of leakage detection fluid (LDF).**

## 13.2.1 Emission check



In order to be able to check on the boiler's emission during its years of operation, it is recommended to measure the maximum air displacement of the boiler on commissioning. This value may be different for each boiler type.

This measuring is only worthwhile if the value is known on commissioning.

The following tasks have to be carried out to enable measuring this value:

- Press down the arrow buttons simultaneously for 2 seconds.  
*The screen turns green;*
- Press the right arrow button until you see Service chapter.;
- Press OK;
- Press the right arrow button until Airflush is displayed;
- Press OK;  
*The screen displays Airflush off;*

Only for XL110 and XL140:

- Press the right arrow button to select burner A.  
*The exchanger symbol displays the selected burner (AB, A or B)*
- Open the top test nipple (fig. 13.2.1.a);
- Connect the hose of the digital pressure meter to the top test nipple of the gas valve.

OUT: 0-pressure adjustment  
MIN: Gas pressure

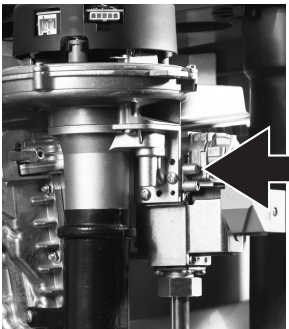

Measuring point air flow figure 13.2.1.a



**Measuring is only allowed using the top test nipple (refer to arrow).**

- Press on the + button until the maximum value (100%).  
*The ventilator will start running up to its max. revolutions per minute RPM (burner stays on)*
- Measure the under-pressure and record the value.  
*During the next boiler check, the under-pressure value may have decreased by 20% max. compared to the value on commissioning. If this value has decreased less than 20% the boiler does not require any maintenance.*
- Press the – button until *off* is displayed (keep pushed down)

This ends the procedure for burner A.

Only for XL110 and XL140:

- Press the return button 1x
- Press the right arrow button to select burner B.  
*The exchanger symbol displays the selected burner (AB, A or B)*

Repeat the procedure for burner B.

- Press the return button to return to the original read-out.



## 13.2.2 Check O<sub>2</sub>



The O<sub>2</sub> percentage is set by the factory. It has to be checked during inspection, maintenance and faults.

It can be checked as follows:

- Ensure that the boiler is at maximum load and can dump the heat generated;
- Press down the arrow buttons simultaneously for 2 seconds.  
*The screen turns green;*
- Press the right arrow button until you see Service chapter.;
- Press OK;  
*The screen displays Throttle;*
- Press OK;  
*The screen displays Throttle off;*

Only for XL110 and XL140:

- Press the right arrow button to select burner A.  
*The exchanger symbol displays the selected burner (AB, A or B)*
  - Calibrate the O<sub>2</sub> meter ;
  - Position the lance of the O<sub>2</sub> meter into the flue outlet test point (refer to fig. 13.2.2.a);
  - Press on the + button until the maximum value (in kW) has been reached;  
*The boiler will be burning at the rated full capacity (value on display in %)*
  - Leave measuring O<sub>2</sub> to the measuring equipment.
- |  |                    |                |
|--|--------------------|----------------|
|  | <b>Natural gas</b> | <b>Propane</b> |
| - O <sub>2</sub> percentage at full load = | 4,7% (+/-0,2%)     | 5,1% (+/-0,2%) |
| - CO/CO <sub>2</sub> ratio less than       | 0.004%             |                |
- If required, you may turn the setting screw to set the correct O<sub>2</sub> percentage.  
(refer to fig. 13.2.2.b).

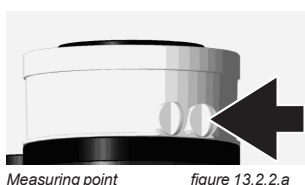

Measuring point figure 13.2.2.a

**Finally, the O<sub>2</sub> percentage at low load must be checked:**

- Press on the - button until the value 1 has been reached.  
*The boiler will be burning at low capacity (value on display in %).*
- Leave measuring O<sub>2</sub> to the measuring equipment and check if the measured O<sub>2</sub> percentage on low load is between following values:

- |  |                    |                |
|--|--------------------|----------------|
|  | <b>Natural gas</b> | <b>Propane</b> |
| - O <sub>2</sub> percentage at <u>low load</u> between | 5,0% and 7,0%      | 5,1% and 7,0%  |
| - CO/CO <sub>2</sub> ratio less than                   | 0.004%             |                |

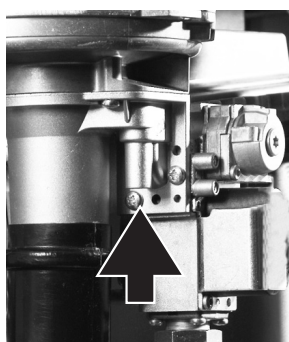

adjusting screw figure 13.2.2.b

Contact ATAG Heating when the measured values is outside this range.

End of measuring:

- Press the - button until *off* is displayed (keep pushed down).

This ends the procedure for burner A.

Only for XL110 and XL140:

- Press the return button 1x
- Press the right arrow button to select burner B.  
*The exchanger symbol displays the selected burner (AB, A or B)*

Repeat the procedure for burner B.

- Press the return button to return to the original read-out.

## 13.3 Maintenance activities

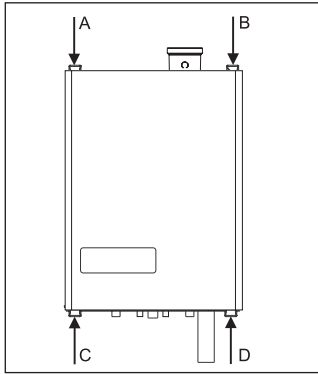

Removing housing figure 13.3.a

Required tools:

- Cross head screwdriver
- ATAG T-handle key set with 3 bits (hex key 4mm, hex key 5mm and cross head PZ2)
- Open end wrench 8mm

The following actions have to be taken in order to be able to carry out maintenance:

- Switch the device off using the mains switch,
- Close the gas tap;

Refer to figure 13.3.a:

- Unscrew the 4 screws of quick-locks A, B, C and D
- Open the 4 quick-locks A, B, C and D and remove the housing (= air box) from the front.



Removing flue pipe figure 13.3.b

Dismantle the internal flue gas pipe as follows (refer to fig. 13.3.b):

- Unplug the flue gas sensor if fitted;
- Press the 2 clips of the siphon adapter (F) and push that part of the flue gas vent pipe (E) down. Leave the siphon adapter (F) hanging on the bottom plate
- Slide the slider (G) in the upper part of the flue gas pipe upward.
- Pull the flue gas pipe (E) forward (both exchangers simultaneously).

**Ventilator unit and burner cassette (refer to fig. 13.3.c, d and e)**

- Remove the plug connections of the gas valve (1) and ventilator (2);
- Unscrew the coupling (3) of the gas unit;
- Replace the gas valve gasket with a new one;
- Unscrew the front cross-slotted screw (4) of the air suction damper (5);
- Loosen the left (9) and right (10) clamp bar a quarter of a turn with the hex key and pull it out in a forward direction. In doing so, pay attention to the turning direction (red check cams);

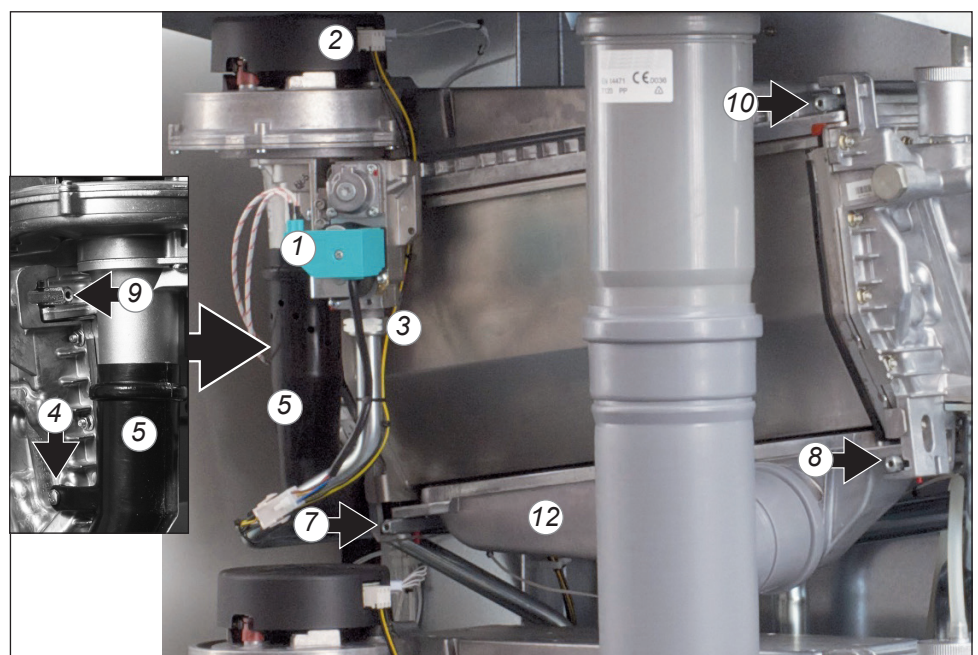

figure 13.3.c

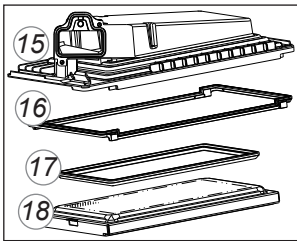
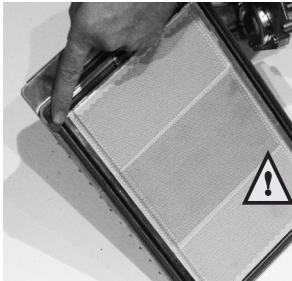

figure 13.3.d

- Pull the complete ventilator unit and heat exchanger's gas valve forward;
- Remove the burner cassette (18) from the ventilator unit;
- Check the burner cassette for wear and tear, pollution and any breakages. Clean the burner cassette with a soft brush and vacuum cleaner. In the case of breakages, always replace the complete burner cassette (18);
- Replace the gasket (17) between the burner (18) and upper casing (15) ;
- Replace the gasket (16) between the upper casing (15) and exchanger:



Position gasket

figure 13.3.e



Removing gas air dividing plate

figure 13.3.f

### **Checking the non return valve in the upper casing, venturi and fan**

- Loosen the 2 screws out of the upper casing with a cross head screwdriver to release the gas air dividing plate. Take out the gas air dividing plate (see fig. 13.3.f)

**The following operations must be performed carefully in relation to the vulnerability of the non return valve.**

- After removing the gas air dividing plate the non return valve becomes visible. Check that the non return valve entire circumference closes / seals completely. The valve should be able to move freely from fully open to fully closed (see fig. 13.3.g). Replace the non return valve if the valve does not seal properly. Follow the instructions supplied with the new part.
- Check the venturi and gas air dividing plate for pollution and clean them with a soft brush in combination with a vacuum cleaner, if necessary.

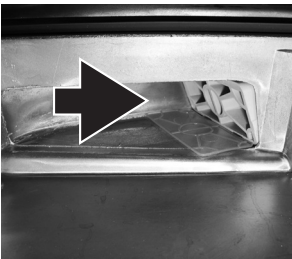

Checking non return valve

figure 13.3.g

If the air box is heavily polluted with dust, it is likely that the fan impeller is also polluted. To clean the fan, it has to be removed from the upper tray and the venturi. Clean the impeller with a soft brush and a vacuum cleaner. Replace the gasket and take care that the new gasket is installed properly when reassembling the fan parts.

Reassembly takes place in reverse order.

### **Heat exchanger**

- Check the heat exchanger for pollution. Clean it, if necessary, with a soft brush and vacuum cleaner. Prevent any dirt from dropping down.  
Rinsing the exchanger with water from the top is not allowed.

Assembly is done in reverse order.

**Ensure during assembly that the clamping bars are properly positioned. They have to be in a vertical position.**

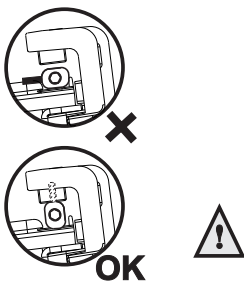

figure 13.3.h

**Ignition electrode**

Replace the ignition electrode when necessary, but certainly every 4 years. This can be checked by reading out the ionization current. The minimum ionization current has to be greater than 2,0 µA at full capacity.

To read out the ionization current follow the instructions:  
From the standard blue screen display:

1. Press down the arrow buttons simultaneously for 2 seconds;
2. Continue with point 3.

From the setting level with a green screen:

3. Select using the right arrow button: Info;
4. Press the OK button;
5. Press the right arrow button until: Burners
6. Press the OK button;
7. Press the right arrow button until: Flame.

*The ionization current is shown here in µA. With the + and - button the value of burner A and B can be shown (heat exchanger symbol turns from A to B).*

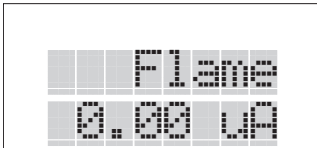

If the sight glass is damaged, the complete ignition electrode has to be replaced. Replace as follows:

- Remove the plug connections of ignition electrode;
- Push the clips on either side of the electrode to the outside and remove the electrode;
- Remove and replace the gasket;

Assembly is done in reverse order.

**Condensate container (refer to fig. 13.3.c and i)**



**Take precautions to prevent condensate falling on electronics and other boiler parts during dismantling to avoid damage of these parts.**

- Remove the short clamping bars (7 and 8) by loosening them a quarter of a turn with the hex key. In doing so, pay attention to the turning direction (red check cams).
- Pull the clamping bars forward and away from underneath the condensate container.
- Carefully push the condensate container (12) down and remove it from the front;
- Replace the condensate container gasket by a new one.
- Clean the polluted condensate container with water and a hard brush.
- Check the condensate container for any leakages.

Assembly is done in reverse order.

Ensure proper all around sealing of the gasket when installing the condensate container.

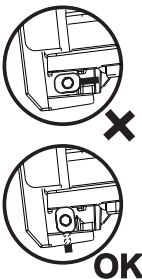

figure 13.3.i



**Ensure during assembly that the clamping bars are properly positioned. They have to be in a vertical position.**



**During maintenance always replace the gaskets of dismantled parts.**

### Siphon (refer to fig. 13.3.j)



Place a collector (i.e. a bucket) under the siphon to collect the dirty and aggressive condensate water. Wear protective clothing like latex gloves and safety glasses.

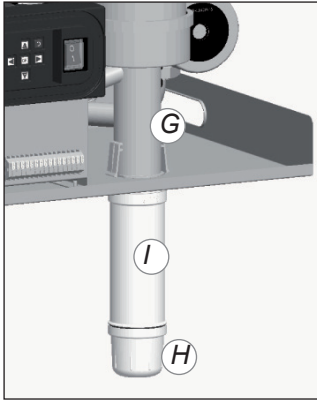

Siphon

figure 13.3.j

- Dismantle the siphon by unscrewing the siphon cup (H).  
Check the siphon cup (H), siphon adapter (G) and siphon pipe (I) for pollution.
- Clean these parts by rinsing them with water.
- Re-grease the O-rings with acid-free O-ring grease to facilitate easy assembly.
- If the siphon shows any leakage, the whole siphon has to be replaced:

Take the device back into operation and conduct a flue gas analysis (refer to chapter Check O<sub>2</sub>).

## 13.4 Counter running hours

From factory a fixed number of running hours is set for service interval. The number of running hours cannot be changed. After expiring of the number of running hours the message "Service" (when read-out is on "Good") or Mx24sc11 (when read-out is on boiler status) is displayed on the screen. There is no message when the boiler is set to the operational status read-out.

During the messages "Service" and "Mx24sc11" the boiler remains fully operational. If the maintenance activities, as described hereinbefore, have been carried out, the counter has to be reset.

To reset the counter, the following procedure has to be followed (starting from a blue screen):

- Press down the arrow buttons simultaneously for 2 seconds.  
*The screen turns green;*

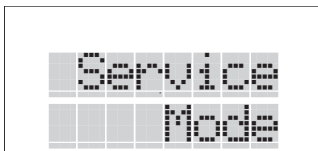

- Press the right arrow button until you see Service chapter.;

- Press OK;

- Press the right arrow button until you see Reset Counters;

- Press OK;  
*The screen displays Confirm Reset;*

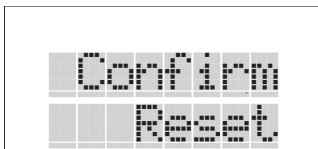

- Press OK to confirm the reset function;  
*The screen displays Confirm Reset;*

The counter is reset to the same number of hours as set from factory. The message "SERVICE" or "Mx24sc11" is no longer displayed.

## 13.5 Warranty

The warranty terms and conditions are provided on the warranty card which is supplied with the boiler.



## 14 Error report

On the display, errors found are shown in the form of a message or blocking on a blue screen or an error on a red screen.

- Blocking *This is a temporary error that will sort itself out, or it will block the boiler after several attempts (error) (Except: Bx01sc01 = reset)*
- Error *Error implies a blocking of the boiler and can only be solved by a reset and/or intervention of a service engineer.*
- Message *Implies a message such as low water pressure, but the device will remain operational.  
Point of attention requiring short-term intervention.*

### OpenTherm error messages

The coding of the transmitted Error Messages on a OpenTherm controller is displayed as follows:  
(E) EB (E = Error Code = B and boiler number)  
example: Error Code Ex02SC02 on boiler 6 will appear as (0) 26

The code consists of a Main Code and a Subcode

Main code	Blocking	= B
Main code	Error	= E
Main code	Message	= M
Followed by a character	0	= boiler
	1	= burner A
	2	= burner B

Subcode always starts with sc

Bx01sc01	Fan does not run on correct speed (Reset necessary). Fan defective.
Bx03sc01*	Flow sensor T1 open
Bx03sc02*	Flow temperature T1 too high
Bx03sc03*	Flow sensor T1a open
Bx03sc04*	Flow temperature T1a too high
Bx05sc01*	Return sensor T2 open
Bx05sc02*	Return temperature T2 higher than flow temperature
Bx08sc01*	General purpose contact open
Bx12sc01*	Water pressure sensor open
Bx12sc02*	Water pressure sensor closed
Bx12sc03*	Water pressure lower than 0.7bar. Top up
Bx12sc04*	Water pressure too high. Decrease pressure
Bx12sc05*	No pressure increase on pump start
Bx13sc01*	$\Delta T$ between T1 and T2 too high
Bx15sc01*	Communication error between controls

Ex01sc01*	Fan does not run on correct speed. Fan defective.
Ex02sc01*	No flame after 4 start attempts
Ex02sc02*	Insufficient ionisation
Ex04sc01*	Flow temperature T1 too high
Ex04sc02*	Flow sensor T1 closed
Ex04sc03*	Flow temperature T1a too high
Ex04sc04*	Flow sensor T1a closed
Ex06sc01*	Return temperature T2 higher than flow temperature
Ex06sc02*	Return sensor T2 closed
Ex18sc01*	Flame detected when burner should not be operating
Ex14sc01*	$\Delta T$ not fast enough
Ex14sc02*	$\Delta T$ between T1 and T2 > 35°C

M024sc01	DHW sensor T3 open (when P122=1)
M024sc02	DHW sensor T3 closed (when P122=1)
M024sc03	Outside sensor T4 open
M024sc04	Outside sensor T4 closed
M024sc05	Common flow sensor T10 open
M024sc06	Common flow sensor T10 closed
M024sc08	Bus communication: Possibly no bus communication cable connected
Mx24sc09	Temperature increase (Gradient) not fast enough after burner start
Mx24sc10	$\Delta T$ between T1 and T2 > 35°C when gas valve opened
Mx24sc11	Service required

\* When this code is shown with an M instead of a B or E then a reset with the reset button is possible.

## Annex A Technical specifications

### Technical specifications Natural gas

Boiler type	ATAG XL-Series			
	XL70	XL110	XL140	
Type heat exchanger	OSS4	OSS4 OSS2	OSS4 OSS4	
Input Hs CH	kW	68,5	107,9	136,4
Qn Input Hi CH	kW	61,8	97,3	123
Efficiency class according BED		★★★★	★★★★	★★★★
Efficiency (50/30°C low load, Hi)	%	110,2	110,3	110,2
Efficiency according EN677 / EN15417 * (36/30°C part load, Hi)	%	109,8	109,2	108,9
Efficiency according EN677 / EN15417 * (80/60°C full load, Hi)	%	97,3	97,6	97,6
Modulation range CH (capacity 80/60°C)	kW	8,8 - 60,1	14,8 - 95,0	17,6 - 120,0
Modulation range CH (capacity 50/30°C)	kW	9,9 - 65,0	16,8 - 102,3	19,8 - 130,0
Flue gas pressure	Pa	175	195	195
Nox class EN483			6	
Nox according to EN483 and EN15420 (year measurement)	mg/kWh	34,02	35,15	36,23
Nox at 0% O <sub>2</sub> according to EN483 and EN15420	mg/m <sup>3</sup>	38,02	40,07	41,30
Nox at 3% O <sub>2</sub> according to EN483 and EN15420	mg/m <sup>3</sup>	33,34	34,45	35,51
O <sub>2</sub>	%		4,7	
CO	ppm		100	
Flue gas non-return valve present		yes	yes	yes
Flue gas temp. CH (80/60°C on full load)	°C	76	73	77
Flue gas temp. CH (50/30°C on low load)	°C	30	30	30
Gas consumption G20 CH (at 1013 mbar/15°C)	m <sup>3</sup> /h	6,53	10,29	13,01
Gas category		II2H3P		
Boiler flue category		B23 B33 C13 C33 C43 C53 C63 C83 C93		
Electr. power consumption max.	W	161	250	322
Electr. power consumption part load	W	44	86	88
Electr. power consumption stand by	W	2,5	3,7	3,7
Current	V/Hz	230/50	230/50	230/50
Degree of protection acc. EN 60529		IPX4D (IPX0D for B <sub>23</sub> & B <sub>33</sub> )		
Weight (empty)	kg	65	83	87
Mounting weight	kg	54	72	76
Width	mm	660	660	660
Height	mm	1065	1065	1065
Depth	mm	460	460	460
Mounting height (excl. flue connection)	mm	1715	1715	1715
Water content CH	l	7	12	14
Overrun time pump CH	min	2	2	2
P <sub>MS</sub> Water pressure min./max.	bar	0,7 / 4	0,7 / 4	0,7 / 4
Flow temperature max.	°C	85	85	85
Type pump Grundfos UPM**	OSS4 OSS2	GEO 25-85 -	GEO 25-85 2 25-60	GEO 25-85 GEO 25-85
Label				
CE product identification number (PIN)				0063CM3648

\* EN15417 = Specific requirements for condensing boilers with a nominal heat input exceeding 70 kW up to 1000 kW.

\*\* There are no pump height values specified because the XL boiler should always be connected to a low velocity header.

### Technical specifications Propane gas

Boiler type	XL70	XL110	XL140	
Type heat exchanger	OSS4	OSS4 OSS2	OSS4 OSS4	
CO <sub>2</sub>	%	10,5	10,5	10,5
O <sub>2</sub>	%	5,1	5,1	5,1
Restriction plate diameter	mm	5,7	5,7 (OSS4) 5,2 (OSS2)	5,7
Pre-pressure	mbar	see data plate propane		
Load(H <sub>i</sub> )	kW	61,8	94,9	123
Gas consumption G31 (1015mbar, 15°C)	kg/h m <sup>3</sup> /h	4,80 2,52	7,37 3,87	9,54 5,01
Modulation range (80/60°C)	kW	30,3-60,1	45,9-95,0	60,5-120,0
Modulation range (50/30°C)	kW	33,0-65,0	50,7-102,3	66,0-130,0

### ErP specifications according to European Directive 2010/30/EU

Boiler type	ATAG XL-Series			
	XL70	XL110	XL140	
Seasonal space heating energy efficiency class	A			
Rated heat output of preferential heater (P <sub>n</sub> )	kW	60	95	120
Annual energy consumption (Q <sub>HE</sub> )	GJ	20	30	39
Seasonal space heating energy efficiency of the preferential heater (η <sub>s</sub> )	%	94	94	94
Sound power level, indoors (L <sub>WA</sub> )	dB	51	52	53

## Annex B System water additives

When the filling water requirements as referred to in chapter Water Quality have been met, certain additives are allowed for the below mentioned applications and related dosage. Warranty on ATAG delivered installation products expires, if these additives and concentrations are not used in accordance with this annex.

Additive type	Supplier and specifications	Max. concentration	Application
Corrosion inhibitors	Sentinel X100 Corrosion resistant protection agent of CH systems Kiwa certified	1-2 l/100 litres CH water content	Aqueous solution of organic and inorganic agents preventing corrosion and scale forming
	Fernox F1 Protector Corrosion resistant protection agent of CH systems Kiwa certified KIWA-ATA K62581, Belgaqua certified Cat III	500 ml can or 265 ml Express / 100 litres CH water content	Preventing corrosion and scale forming
Anti-freeze	Kalsbeek Monopropyleneglycol / propane-1,2-diol + inhibitors AKWA-Colpro KIWA-ATA Nr. 2104/1	50% w/w	Anti-freeze
	Tyfocor L Monopropyleneglycol / propane-1,2-diol + inhibitors	50% w/w	Anti-freeze
	Sentinel X500 Monopropyleneglycol + inhibitors Kiwa certified	20-50% w/w	Anti-freeze
	Fernox Alphi 11 Monopropyleneglycol + inhibitors Kiwa certified KIWA-ATA K62581, Belgaqua certified Cat III	25-50% w/w	Anti-freeze in combination with F1 Protector
System cleaners	Sentinel X300 Solution of phosphate, organic heterocyclic compounds, polymers and organic bases Kiwa certified	1 litre / 100 litres	For new CH installations Removes oils/grease and flow control agents
	Sentinel X400 Solution of synthetic organic polymers	1-2 litres / 100 litres	For cleaning existing CH-installations Removes sediments.
	Sentinel X800 Jetflo Aqueous emulsion of dispersants, moistening agents and inhibitors	1-2 litres / 100 litres	For cleaning new and existing CH-installations Removes iron and lime-related sediments.
	Fernox F3 Cleaner Liquid pH neutral universal cleaner for pre-commissioning new systems	500 ml / 100 litres	For cleaning new and existing CH-installations Removes sludge, limescale and other debris.
	Fernox F5 Cleaner, Express pH neutral universal cleaner concentrate for pre-commissioning new systems	295 / 100 litres	For cleaning new and existing CH-installations Removes sludge, limescale and other debris.

ATAG support the use of inhibitors suitable for mixed metal applications that keep the pH level between 6 and 8. Dosage levels as per manufacturers instructions. Preferred inhibitor suppliers are Fernox and Sentinel.



# Annex C Dimensions

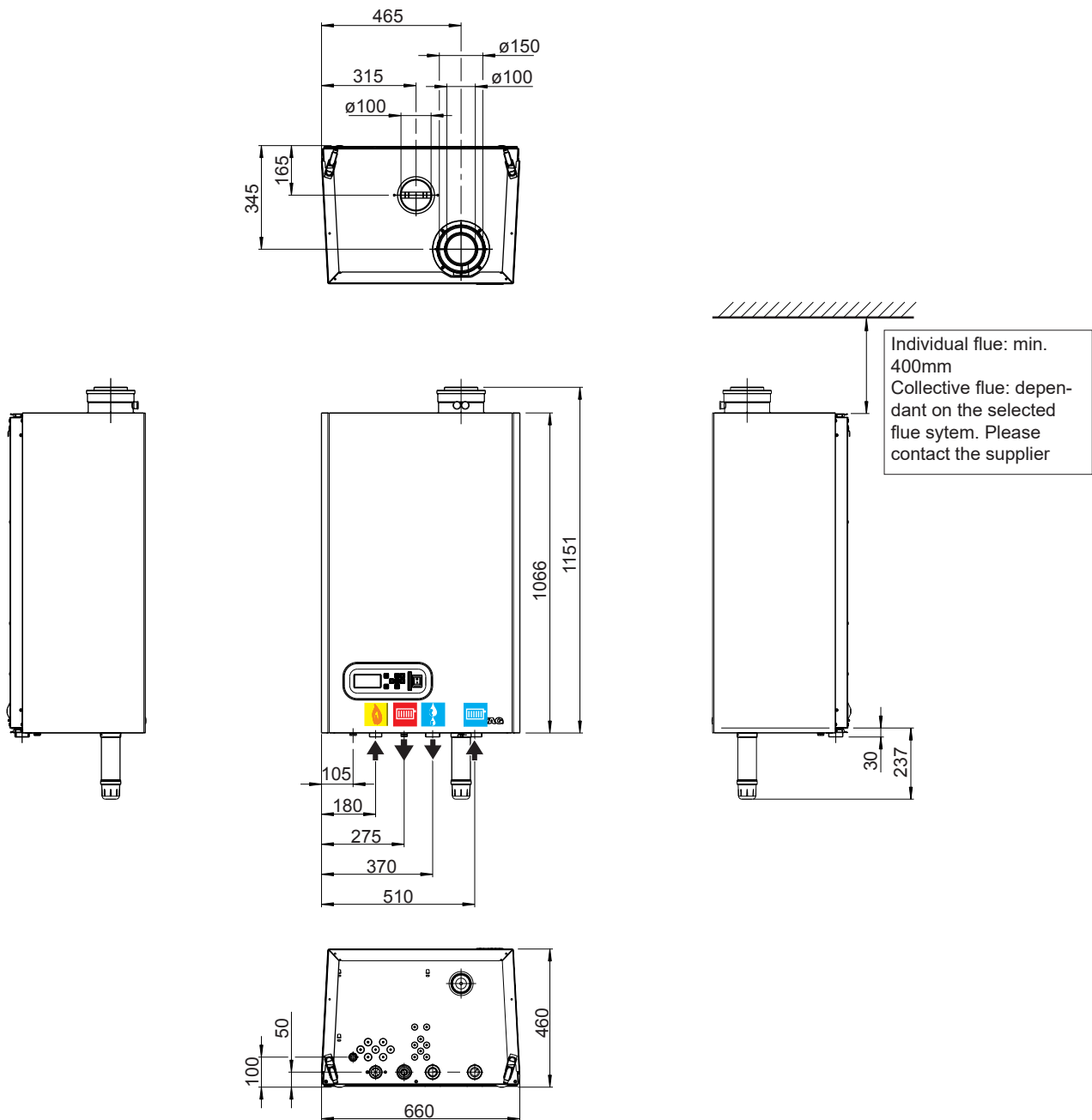





Boiler type		ATAG XL-Series		
		XL70	XL110	XL140
Concentric flue connection	mm	100/150	100/150	100/150
Parallel flue connection	mm	2x 100	2x 100	2x 100
 Gas pipe - g		1 1/4"	1 1/4"	1 1/4"
 Flow pipe CH - a		1 1/2"	1 1/2"	1 1/2"
 Return pipe CH - r		1 1/2"	1 1/2"	1 1/2"
 Condensate drain pipe - c	mm	26	26	26

Table connection diameters

Table C.a

dimensions (in mm)

Figure C.a

ATAG XL 2 boilers free-standing in line

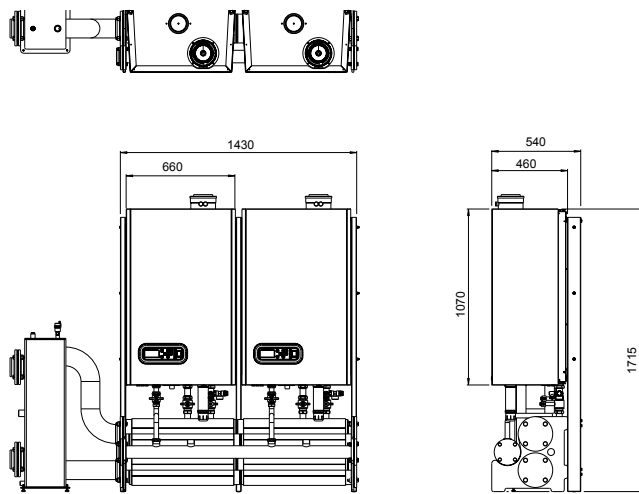

ATAG XL 3 boilers free-standing back-to-back

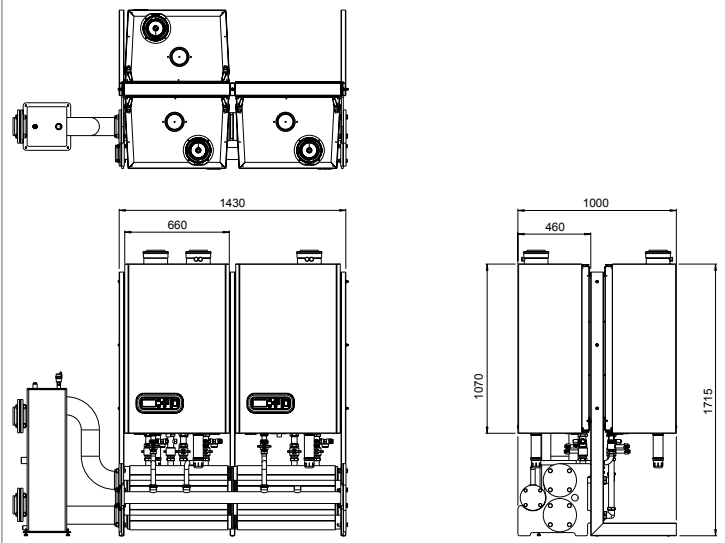

ATAG XL 4 boilers free-standing in line

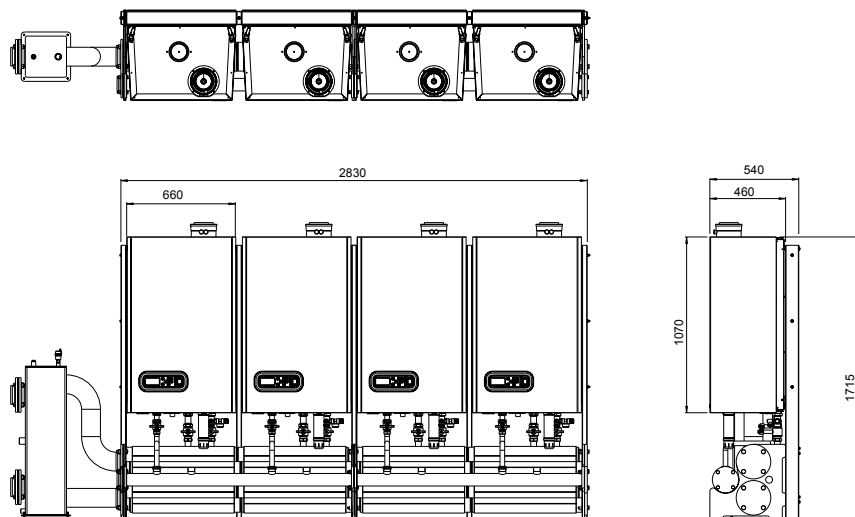

ATAG XL 8 boilers free-standing in line

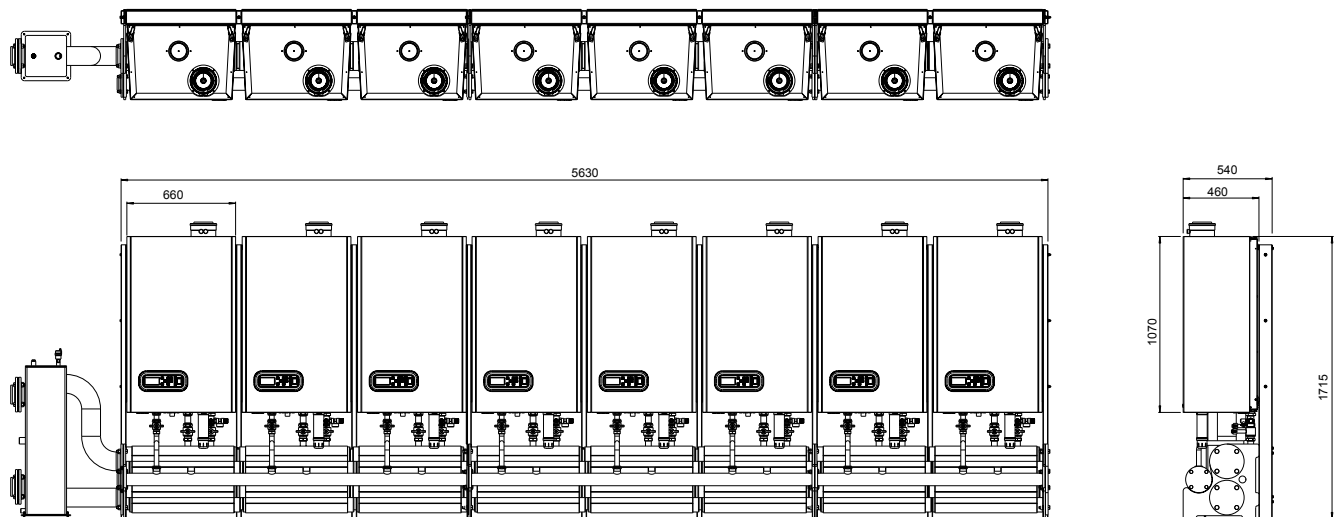

Dimensions flue connections

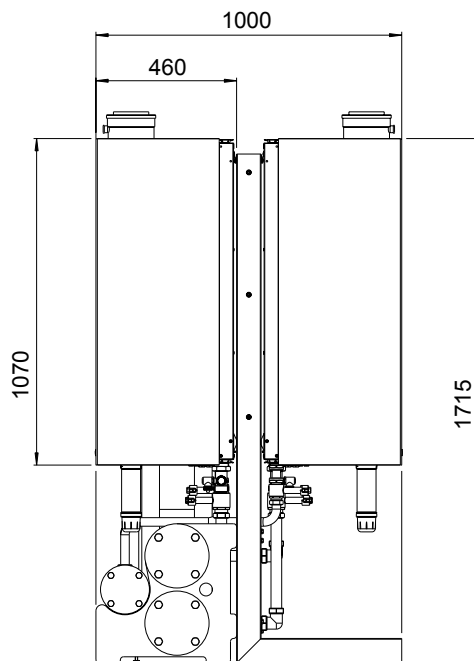
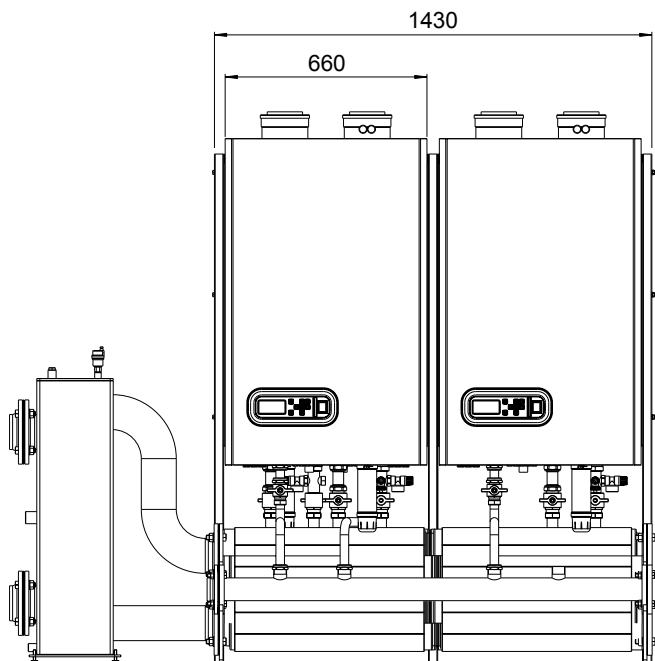
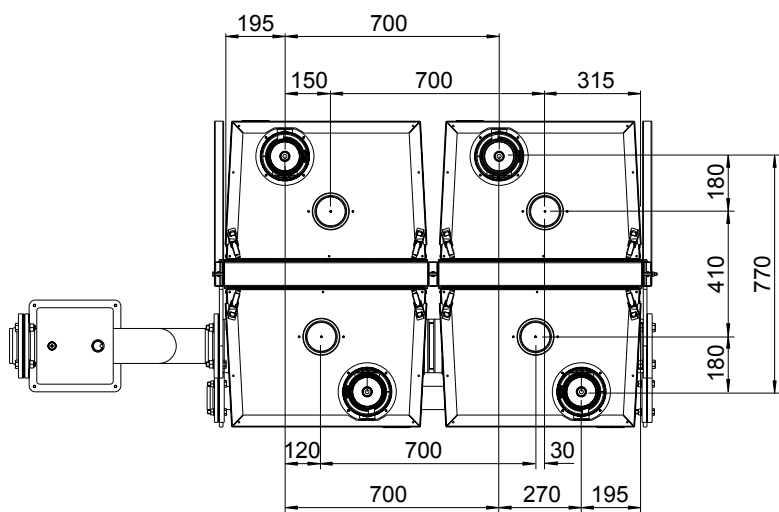

Dimensions low velocity header DN65 until 452kW

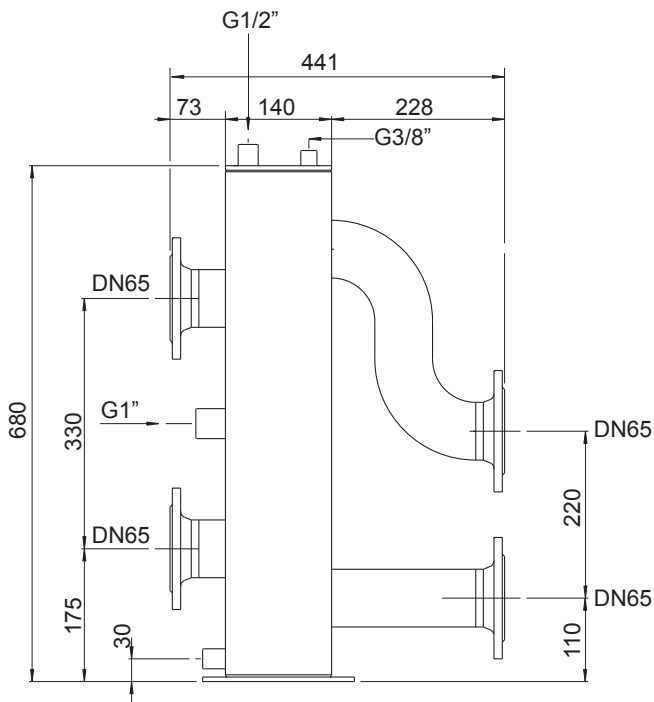

Dimensions main header

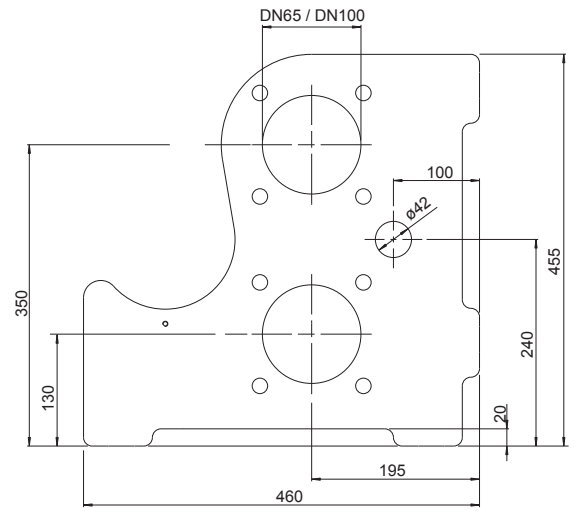

L 2/4 places = 1398mm (DN65/DN100)  
L 3/6 places = 2098mm (DN65/DN100)

Dimensions low velocity header DN100 until 960kW

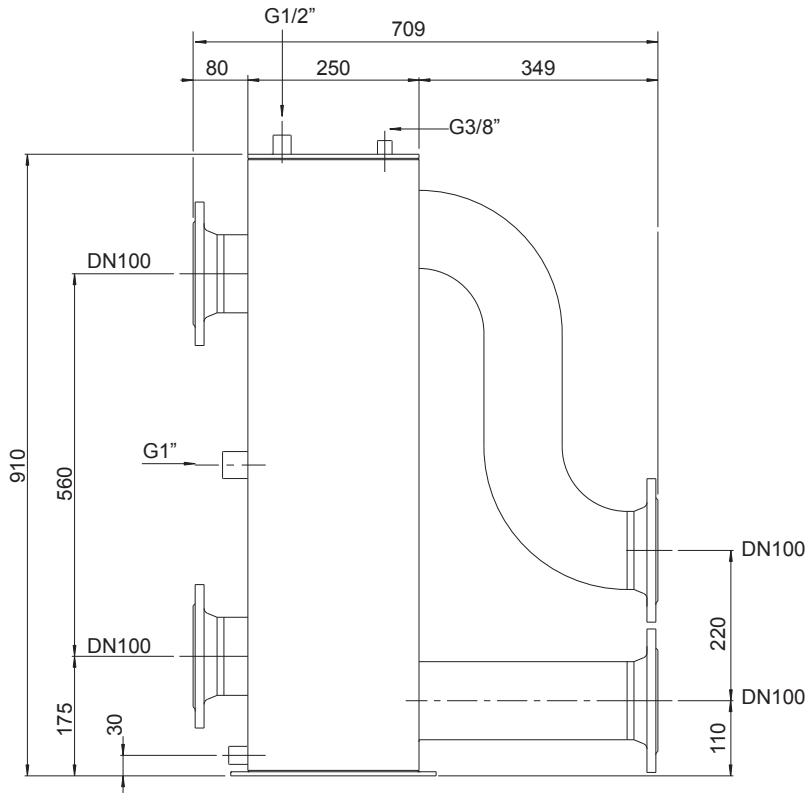

Dimensions bend DN65 and DN100

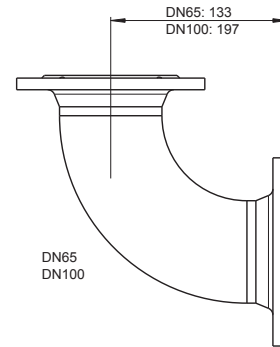

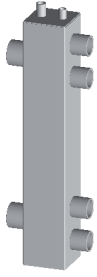

1 XL boiler, wall hung

2 XL boilers, wall hung, max. 200kW

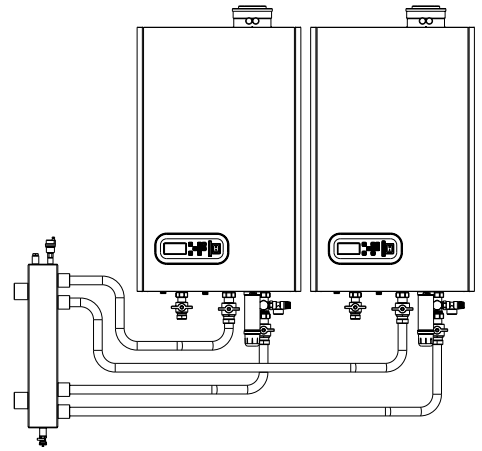
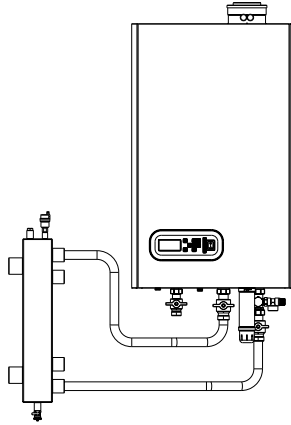
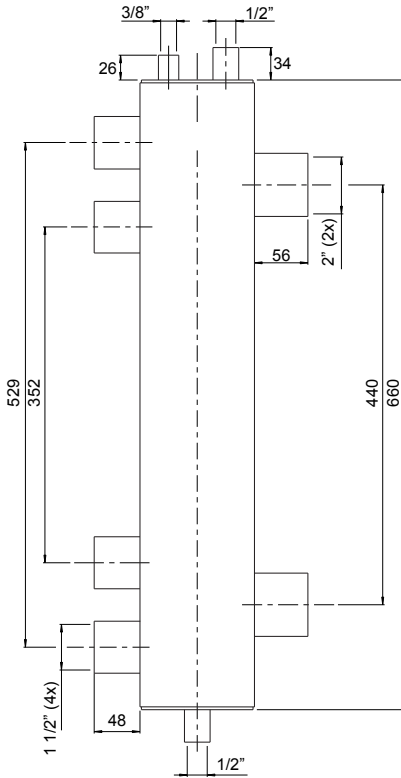

1 XL boiler, free-standing

2 XL boilers, free-standing, max. 200kW

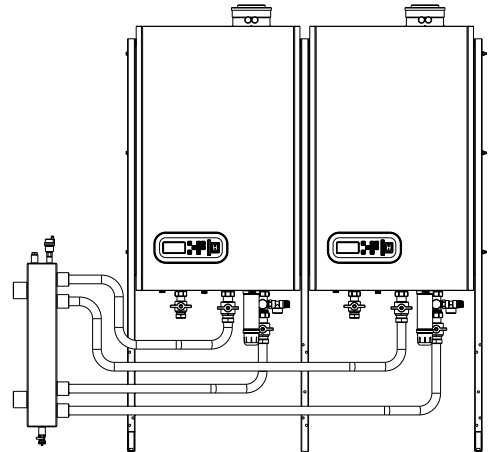
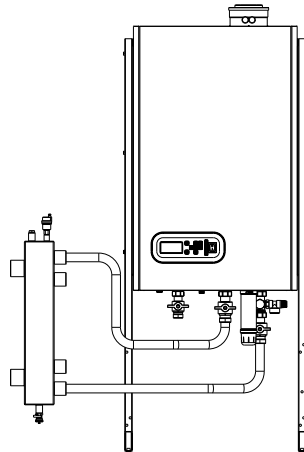

		wall hung		free standing	
		1	2	1	2
Number of XL-boilers (XL70, XL110, XL140)					
Necessary articles:					
AX00010U	L-shape frame for back to back alignment			2	2
AX00020U	I-shape frame for line alignment				1
AX00030U	Boiler frame			1	2
AX00470U	Low velocity header for 1 or 2 boilers (max. 200kW)	1	1	1	1
AX00480U	Boiler connection set for single boiler	1	2	1	2
AX00600U	Bus communication cable		1		1
AX00630U	Common flow sensor 10kOhm T3/T10	1	1	1	1

Supply of connection pipes, fittings and brackets by third party.

## Annex D Resistance table sensors

### Resistance table sensors

Outside sensor T4 NTC1k (25°C)		Common flow sensor T10 NTC10k (25°C)	
Temperature [°C]	Resistance [Ohm]	Temperature [°C]	Resistance [Ohm]
-10	4.574	-10	55.047
-9	4.358	0	32.555
-8	4.152	10	19.873
-7	3.958	12	18.069
-6	3.774	14	16.447
-5	3.600	16	14.988
-4	3.435	18	13.674
-3	3.279	20	12.488
-2	3.131	22	11.417
-1	2.990	24	10.449
0	2.857	26	9.573
1	2.730	28	8.779
2	2.610	30	8.059
3	2.496	32	7.406
4	2.387	34	6.811
5	2.284	36	6.271
6	2.186	38	5.779
7	2.093	40	5.330
8	2.004	42	4.921
9	1.920	44	4.547
10	1.840	46	4.205
11	1.763	48	3.892
12	1.690	50	3.605
13	1.621	52	3.343
14	1.555	54	3.102
15	1.492	56	2.880
16	1.433	58	2.677
17	1.375	60	2.490
18	1.320	62	2.318
19	1.268	64	2.159
20	1.218	66	2.013
21	1.170	68	1.878
22	1.125	70	1.753
23	1.081	72	1.638
24	1.040	74	1.531
25	1.000	76	1.433
26	962	78	1.341
27	926	80	1.256
28	892	82	1.178
29	858	84	1.105
30	827	86	1.037
35	687	88	974
40	575	90	915

**CE DECLARATION OF CONFORMITY**

Hereby declares ATAG Verwarming Nederland BV that,  
the condensing boiler types: ATAG

XL70 XL110 XL140

are in conformity with the following standards:

EU Gas Appliance Regulation	2016/426/EU	EN 15502-1:	2012
		EN 15502-2-1:	2012
		EN 60335-1:	2011
		EN 60335-2-102:	2010
Boiler Efficiency Directive	92/42/EEC	EN 15502-2-2:	2014
Low Voltage Directive	2014/35/EU	EN 60335-1:	2011
		EN 60335-2-102:	2010
EMC Directive	2014/30/EU	EN 61000-3-2:	2013
		EN 61000-3-3:	2014
		EN 60335-2-102:	2010
		EN 55014-1:	2011
		EN 55014-2:	2008
Ecodesign Directive	2009/125/EC	EN 13203-2:	2014
		EN 15036-1:	2006
		EN 15502-1:	2012
		regulation (EU) 813/2013	

This product is designated with CE number:

**CE – 0063CM3648**

and that the products are in conformity with EC type-examination certificate number E0430, as stated by KIWA Nederland BV, The Netherlands.

Date : 16 April 2018

Signature :



Full name : Drs. C. Berlo  
CEO

**ATAG**  
**Verwarming**

Adres: Galileistraat 27, 7131 PE Lichtenvoorde • Postadres: Postbus 105, 7130 AC Lichtenvoorde  
Telefoon: +31(0) 544 391777, Fax: +31(0) 544 391703  
E-mail: info@atagverwarming.com Internet: http://www.atagverwarming.nl

# GAS BOILER SYSTEM COMMISSIONING CHECKLIST

This Commissioning Checklist is to be completed in full by the competent person who commissioned the boiler as a means of demonstrating compliance with the appropriate Building Regulations and then handed to the customer to keep for future reference.

Failure to install and commission according to the manufacturer's instructions and complete this Benchmark Commissioning Checklist will invalidate the warranty. This does not affect the customer's statutory rights.

Customer name:				Telephone number:			
Address:							
Boiler make and model:							
Boiler serial number:							
Commissioned by (PRINT NAME):				Gas Safe register number:			
Company name:				Telephone number:			
Company address:							
				Commissioning date:			
<b>To be completed by the customer on receipt of a Building Regulations Compliance Certificate*</b>							
Building Regulations Notification Number (if applicable):							
<b>CONTROLS</b> (tick the appropriate boxes)							
Time and temperature control to heating		Room thermostat and programmer/timer		Programmable room thermostat			
		Load/weather compensation		Optimum start control			
Time and temperature control to hot water		Cylinder thermostat and programmer/timer		Combination Boiler			
Heating zone valves		Fitted		Not required			
Hot water zone valves		Fitted		Not required			
Thermostatic radiator valves		Fitted		Not required			
Automatic bypass to system		Fitted		Not required			
Boiler interlock				Provided			
<b>ALL SYSTEMS</b>							
The system has been flushed and cleaned in accordance with BS7593 and boiler manufacturer's instructions						Yes	
What system cleaner was used?							
What inhibitor was used?						Quantity	
						litres	
Has a primary water system filter been installed?						Yes	
						No	
<b>CENTRAL HEATING MODE</b> measure and record:							
Gas rate		m <sup>3</sup> /hr		<b>OR</b>		ft <sup>3</sup> /hr	
Burner operating pressure (if applicable)		mbar		<b>OR</b> Gas inlet pressure		mbar	
Central heating flow temperature						°C	
Central heating return temperature						°C	
<b>COMBINATION BOILERS ONLY</b>							
Is the installation in a hard water area (above 200ppm)?						Yes	
						No	
If yes, and if required by the manufacturer, has a water scale reducer been fitted?						Yes	
						No	
What type of scale reducer has been fitted?							
<b>DOMESTIC HOT WATER MODE</b> Measure and Record:							
Gas rate		m <sup>3</sup> /hr		<b>OR</b>		ft <sup>3</sup> /hr	
Burner operating pressure (at maximum rate)		mbar		<b>OR</b> Gas inlet pressure at maximum rate		mbar	
Cold water inlet temperature						°C	
Hot water has been checked at all outlets						Yes	
						Temperature	
						°C	
Water flow rate						l/min	
<b>CONDENSING BOILERS ONLY</b>							
The condensate drain has been installed in accordance with the manufacturer's instructions and/or BS5546/BS6798						Yes	
<b>ALL INSTALLATIONS</b>							
Record the following:		At max. rate:		CO		ppm	
		<b>AND</b>		CO/CO <sub>2</sub>		Ratio	
		At min. rate: (where possible)		CO		ppm	
		<b>AND</b>		CO/CO <sub>2</sub>		Ratio	
The heating and hot water system complies with the appropriate Building Regulations						Yes	
The boiler and associated products have been installed and commissioned in accordance with the manufacturer's instructions						Yes	
The operation of the boiler and system controls have been demonstrated to and understood by the customer						Yes	
The manufacturer's literature, including Benchmark Checklist and Service Record, has been explained and left with the customer						Yes	
Commissioning Engineer's Signature							
Customer's Signature							
(To confirm satisfactory demonstration and receipt of manufacturer's literature)							

\*All installations in England and Wales must be notified to Local Authority Building Control (LABC) either directly or through a Competent Persons Scheme. A Building Regulations Compliance Certificate will then be issued to the customer.





# SERVICE RECORD

It is recommended that your heating system is serviced regularly and that the appropriate Service Interval Record is completed.

## Service Provider

Before completing the appropriate Service Record below, please ensure you have carried out the service as described in the manufacturer's instructions. Always use the manufacturer's specified spare part when replacing controls.

<b>SERVICE 01</b>					Date:
Engineer name:					
Company name:					
Telephone No:					
Gas safe register No:					
Record:	At max. rate:	CO	ppm	<b>AND</b>	CO <sub>2</sub> %
	At min. rate: (Where Possible)	CO	ppm	<b>AND</b>	CO <sub>2</sub> %
Comments:					
Signature					

<b>SERVICE 02</b>					Date:
Engineer name:					
Company name:					
Telephone No:					
Gas safe register No:					
Record:	At max. rate:	CO	ppm	<b>AND</b>	CO <sub>2</sub> %
	At min. rate: (Where Possible)	CO	ppm	<b>AND</b>	CO <sub>2</sub> %
Comments:					
Signature					

<b>SERVICE 03</b>					Date:
Engineer name:					
Company name:					
Telephone No:					
Gas safe register No:					
Record:	At max. rate:	CO	ppm	<b>AND</b>	CO <sub>2</sub> %
	At min. rate: (Where Possible)	CO	ppm	<b>AND</b>	CO <sub>2</sub> %
Comments:					
Signature					

<b>SERVICE 04</b>					Date:
Engineer name:					
Company name:					
Telephone No:					
Gas safe register No:					
Record:	At max. rate:	CO	ppm	<b>AND</b>	CO <sub>2</sub> %
	At min. rate: (Where Possible)	CO	ppm	<b>AND</b>	CO <sub>2</sub> %
Comments:					
Signature					

<b>SERVICE 05</b>					Date:
Engineer name:					
Company name:					
Telephone No:					
Gas safe register No:					
Record:	At max. rate:	CO	ppm	<b>AND</b>	CO <sub>2</sub> %
	At min. rate: (Where Possible)	CO	ppm	<b>AND</b>	CO <sub>2</sub> %
Comments:					
Signature					

<b>SERVICE 06</b>					Date:
Engineer name:					
Company name:					
Telephone No:					
Gas safe register No:					
Record:	At max. rate:	CO	ppm	<b>AND</b>	CO <sub>2</sub> %
	At min. rate: (Where Possible)	CO	ppm	<b>AND</b>	CO <sub>2</sub> %
Comments:					
Signature					

<b>SERVICE 07</b>					Date:
Engineer name:					
Company name:					
Telephone No:					
Gas safe register No:					
Record:	At max. rate:	CO	ppm	<b>AND</b>	CO <sub>2</sub> %
	At min. rate: (Where Possible)	CO	ppm	<b>AND</b>	CO <sub>2</sub> %
Comments:					
Signature					

<b>SERVICE 08</b>					Date:
Engineer name:					
Company name:					
Telephone No:					
Gas safe register No:					
Record:	At max. rate:	CO	ppm	<b>AND</b>	CO <sub>2</sub> %
	At min. rate: (Where Possible)	CO	ppm	<b>AND</b>	CO <sub>2</sub> %
Comments:					
Signature					

<b>SERVICE 09</b>					Date:
Engineer name:					
Company name:					
Telephone No:					
Gas safe register No:					
Record:	At max. rate:	CO	ppm	<b>AND</b>	CO <sub>2</sub> %
	At min. rate: (Where Possible)	CO	ppm	<b>AND</b>	CO <sub>2</sub> %
Comments:					
Signature					

<b>SERVICE 10</b>					Date:
Engineer name:					
Company name:					
Telephone No:					
Gas safe register No:					
Record:	At max. rate:	CO	ppm	<b>AND</b>	CO <sub>2</sub> %
	At min. rate: (Where Possible)	CO	ppm	<b>AND</b>	CO <sub>2</sub> %
Comments:					
Signature					

\*All installations in England and Wales must be notified to Local Authority Building Control (LABC) either directly or through a Competent Persons Scheme. A Building Regulations Compliance Certificate will then be issued to the customer.







# ATAG