

Qty. Description

1 TP 50-120/2 A-F-A-BQQE-FW1

Note! Product picture may differ from actual product

Product No.: [98810439](#)

Single-stage, close-coupled, volute pump with in-line suction and discharge ports of identical diameter. The pump is of the top-pull-out design, i.e. the power head (motor, pump head and impeller) can be removed for maintenance or service while the pump housing remains in the pipework.

The pump is fitted with an unbalanced rubber bellows seal. The shaft seal is according to EN 12756. Pipework connection is via PN 6/10 DIN flanges (EN 1092-2 and ISO 7005-2).

The pump is fitted with a fan-cooled asynchronous motor.

Controls:

Frequency converter: None

Liquid:

Pumped liquid: Water

Liquid temperature range: -25 .. 120 °C

Selected liquid temperature: 20 °C

Density: 998.2 kg/m³
Technical:

Pump speed on which pump data are based: 2890 rpm

Rated flow: 17.3 m³/h

Rated head: 8.1 m

Actual impeller diameter: 87 mm

Code for shaft seal: BQQE

Curve tolerance: ISO9906:2012 3B2

Materials:

Pump housing: Cast iron
EN-GJL-250
ASTM class 35

Impeller: Stainless steel
EN 1.4301
AISI 304

Installation:

Range of ambient temperature: -30 .. 40 °C

Maximum operating pressure: 10 bar

Max pressure at stated temp: 10 bar / 120 °C

Type of connection: DIN

Size of connection: DN 50

Pressure rating for connection: PN 6/10

Port-to-port length: 280 mm

Flange size for motor: FT100

Electrical data:

Motor type: 80B



Company name:

Created by:

Phone:

Date:

02/01/2024

Qty.	Description
1	<p>Rated power - P2: 0.75 kW Mains frequency: 50 Hz Rated voltage: 1 x 220-230 V Rated current: 4.75-4.60 A Starting current: 390-420 % Cos phi - power factor: 0.99-0.98 Rated speed: 2780-2810 rpm IE Efficiency class: IE2 Motor efficiency at full load: 77.4-77.4 % Motor efficiency at 3/4 load: 76.7-75.3 % Motor efficiency at 1/2 load: 69.7-66.5 % Number of poles: 2 Enclosure class (IEC 34-5): 55 Dust/Jetting Insulation class (IEC 85): F Motor No: 92813907</p> <p>Others: Minimum efficiency index, MEI \geq: 0.45 Net weight: 28.8 kg Gross weight: 32.3 kg Shipping volume: 0.08 m³ Country of origin: HU Custom tariff no.: 84137051</p>

98810439 TP 50-120/2 A-F-A-BQQE-FW1 50 Hz

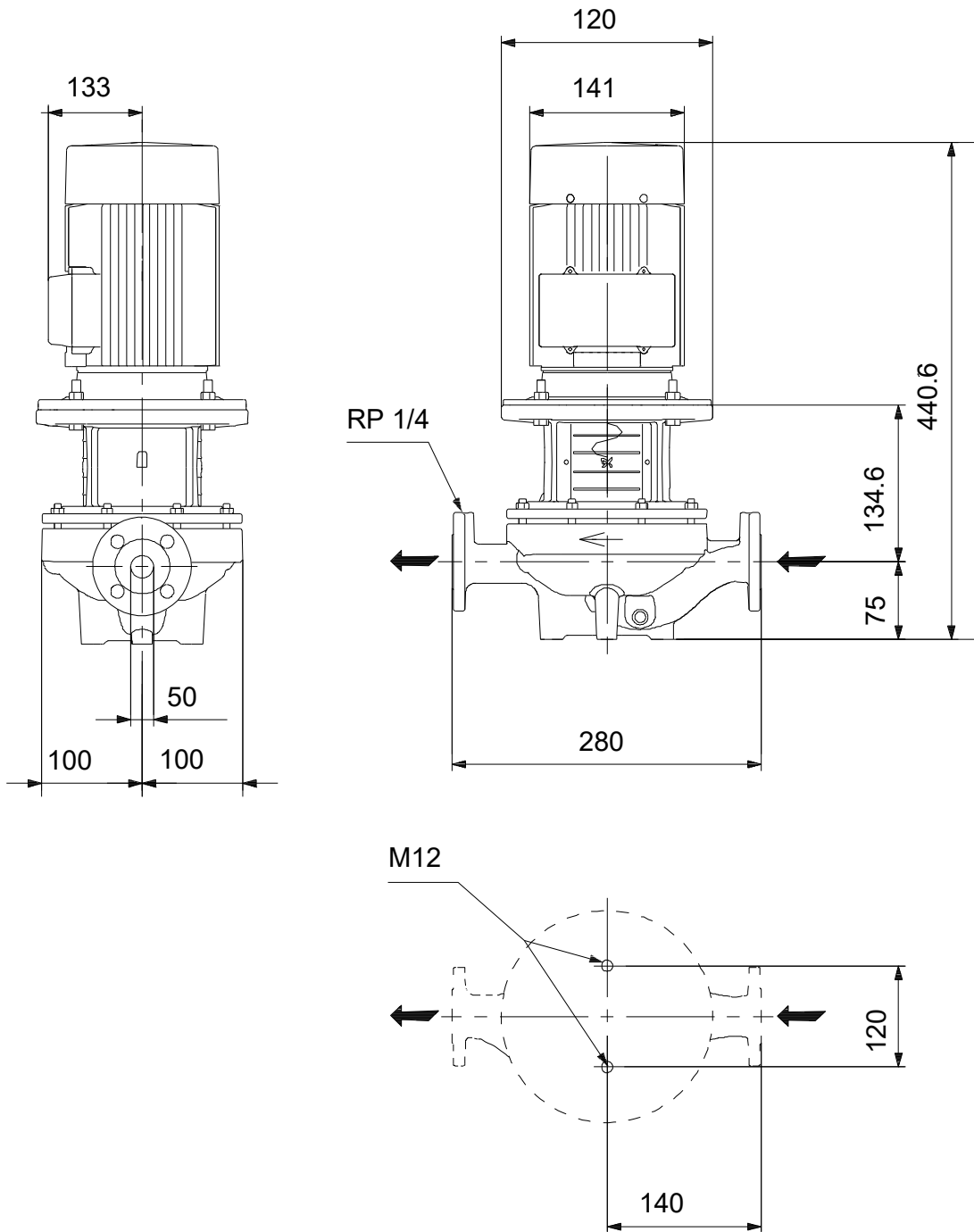

Note! All units are in [mm] unless others are stated.
Disclaimer: This simplified dimensional drawing does not show all details.