

Project:
Reference Number:

Client:
Client Number:
Contact:

Qty.	Description
1	<p data-bbox="199 436 438 470">MAGNA3 40-180 F N</p> <div data-bbox="223 481 558 795">  </div> <p data-bbox="590 772 1061 806" style="text-align: center;">Note! Product picture may differ from actual product</p> <p data-bbox="199 806 470 840">Product No.: 97924353</p> <p data-bbox="199 896 1428 974">The Grundfos MAGNA3 circulator pump is the ideal choice for almost any building project – old or new. With its unrivalled energy efficiency, all-encompassing range and built-in communication capabilities, MAGNA3 is ideal for engineers and specifiers looking to create high-performance heating and cooling systems.</p> <p data-bbox="199 985 1428 1064">The pump is maintenance-free due to the canned-rotor type design. This also means that pump and motor form an integral unit without shaft seal and with only two gaskets for sealing. The bearings are lubricated by the pumped liquid.</p> <p data-bbox="199 1075 1460 1131">MAGNA3 features an intuitive display and allows you to connect wirelessly with the Grundfos GO Remote app, giving you access to advanced reporting and monitoring.</p> <p data-bbox="199 1131 1404 1187">MAGNA3 model E has Bluetooth, which allows you to connect directly to Grundfos Go app on your smart phone without any need for a dongle.</p> <p data-bbox="199 1187 1428 1243">The pump includes fieldbus communication via CIM modules as well as analog and digital inputs and configurable relays.</p> <p data-bbox="199 1243 1460 1299">Control features include AUTOADAPT and FLOWADAPT. FLOWADAPT which reduces the need for throttling valves, thus cutting costs on system components.</p> <p data-bbox="199 1299 1220 1332">MAGNA3 is the superior choice for a wide range of heating and cooling applications, including:</p> <ul data-bbox="199 1332 949 1489" style="list-style-type: none"> • Mixing loops Heating surfaces Air conditioning surfaces Ground-source heat pump systems Smaller chiller applications. <p data-bbox="199 1489 1412 1545">MAGNA3 is a single-phase pump and characterised by having the controller and control display integrated in the control box. The pump also has a built-in differential-pressure and temperature sensor.</p> <p data-bbox="199 1545 1452 1624">The pump housing is available in both cast-iron and stainless-steel versions. The composite rotor can is carbon-fibre reinforced, the bearing plate and rotor cladding are made of stainless steel and the stator housing is made of aluminium. The power electronics are air-cooled.</p> <p data-bbox="199 1624 1460 1713">MAGNA3 incorporates a 4-pole synchronous, permanent-magnet motor (PM motor). This motor type is characterised by higher efficiency than a conventional asynchronous squirrel-cage motor. The pump speed is controlled by an integrated frequency converter.</p>



Company name: national pumps and boilers
Created by:
Phone: 01539 729395
Email: info@nationlapumpsandboilers.co.uk
Date: 28/12/2023

Project:
Reference Number:

Client:
Client Number:
Contact:

97924353 MAGNA3 40-180 F N

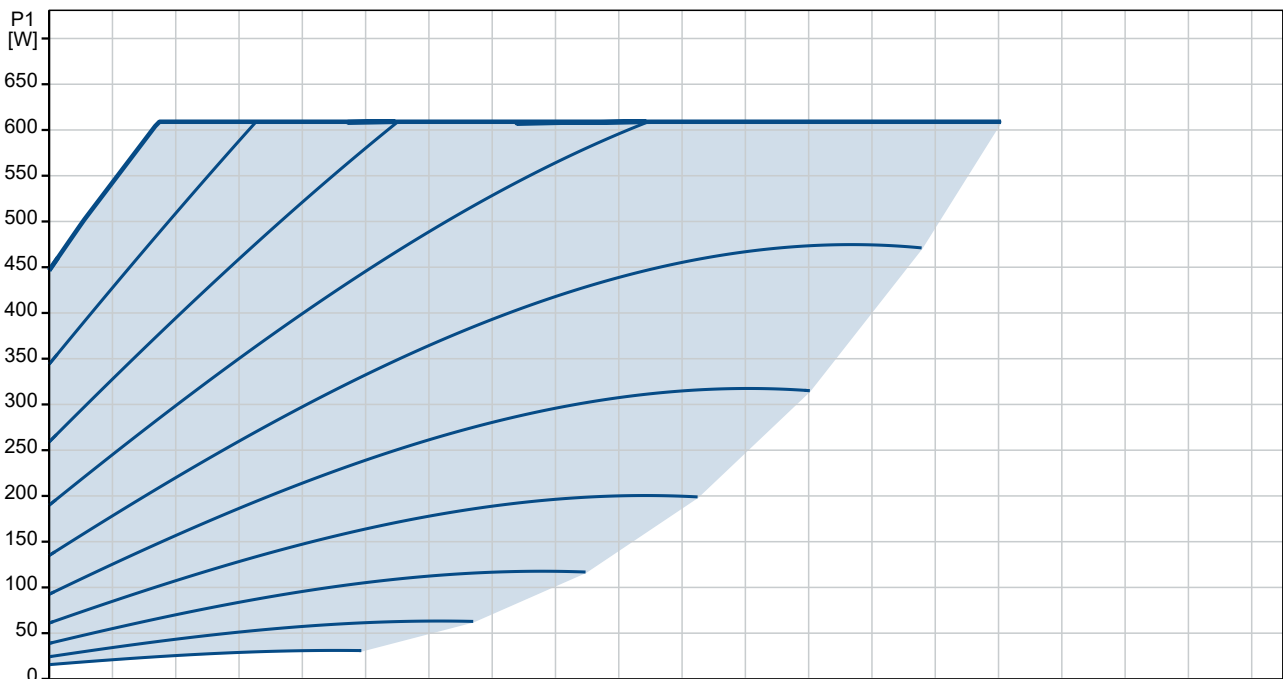
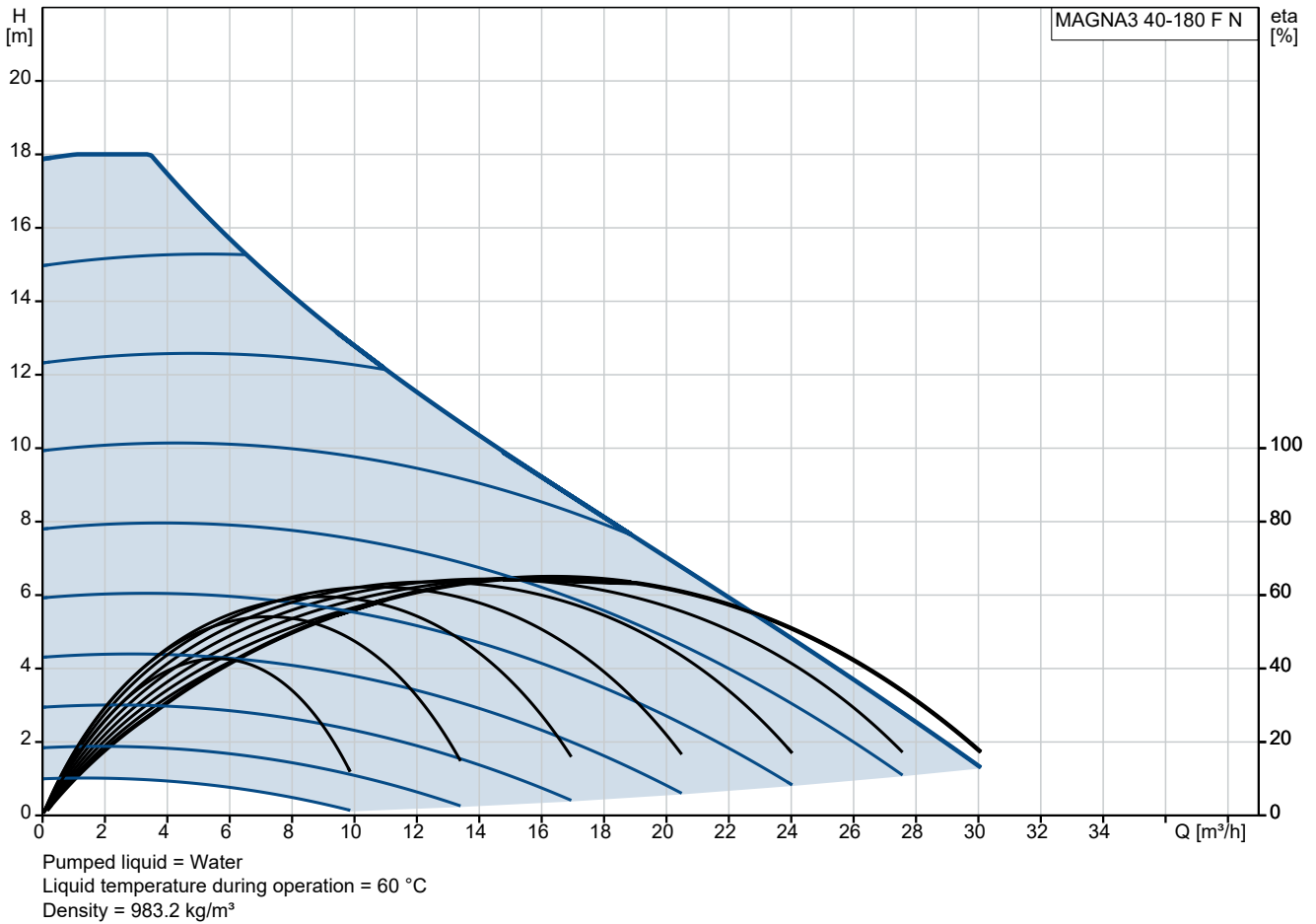

Project:
Reference Number:

Client:
Client Number:
Contact:

Description	Value
General information:	
Product name:	MAGNA3 40-180 F N
Product No:	97924353
EAN number:	5710626494293
Technical:	
Rated flow:	16.04 m ³ /h
Rated head:	9.2 m
Maximum head:	180 dm
TF class:	110
Approvals:	CE, VDE, EAC, MOROCCO, UKCA, TSE, RCM, UkrSEPRO
Approvals for drinking water:	WRAS, ACS, UBA
Model:	E
Materials:	
Pump housing:	Stainless steel
Pump housing:	EN 1.4308
Pump housing:	ASTM A351-CF8
Impeller:	Composite
Installation:	
Range of ambient temperature:	0 .. 40 °C
Maximum operating pressure:	10 bar
Type of connection:	DIN
Size of connection:	DN 40
Pressure rating for connection:	PN 6/10
Port-to-port length:	250 mm
Liquid:	
Pumped liquid:	Water
Liquid temperature range:	-10 .. 110 °C
Selected liquid temperature:	60 °C
Density:	983.2 kg/m ³
Electrical data:	
Maximum power input - P1:	609 W
P1 min.:	16 W
Mains frequency:	50 / 60 Hz
Rated voltage:	1 x 230 V
Minimum current consumption:	0.18 A
Maximum current consumption:	2.78 A
Enclosure class (IEC 34-5):	X4D
Insulation class (IEC 85):	F
Others:	
Energy (EEI):	0.17
Net weight:	16.7 kg
Gross weight:	18.2 kg
Shipping volume:	0.039 m ³
Danish VVS No.:	380982418
Swedish RSK No.:	5803220
Norwegian NRF no.:	9042738
Country of origin:	DE
Custom tariff no.:	84139100
Environmental approvals:	CN ROHS, WEEE

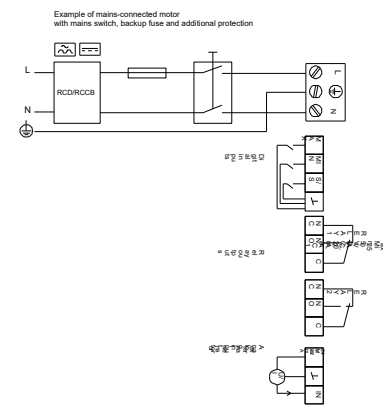
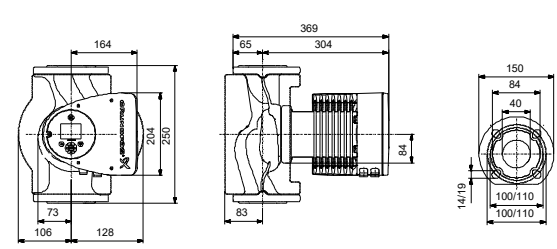
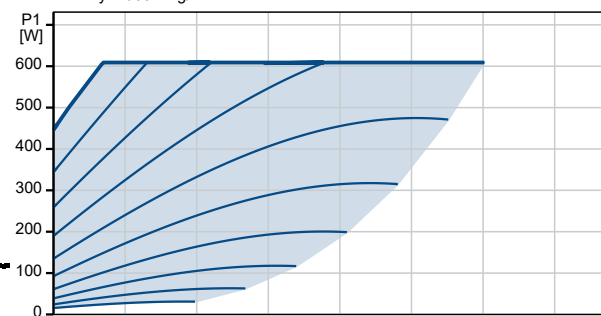
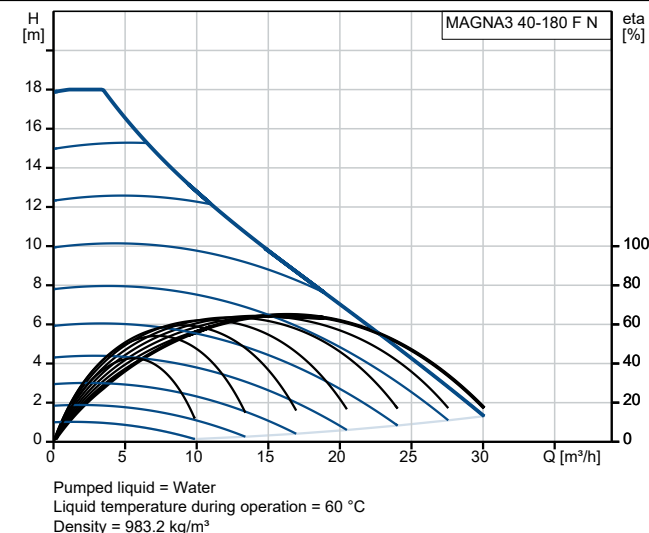

Project:
Reference Number:

Client:
Client Number:
Contact:

97924353 MAGNA3 40-180 F N

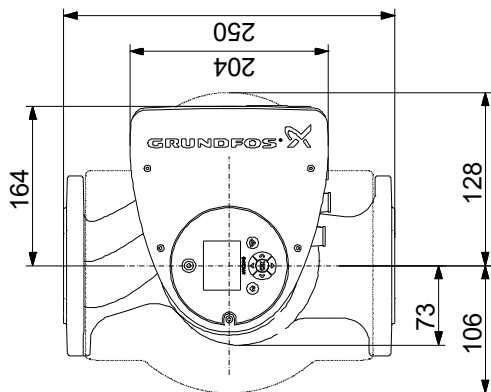
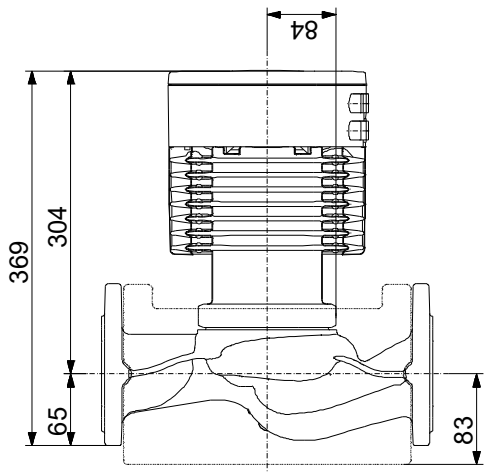
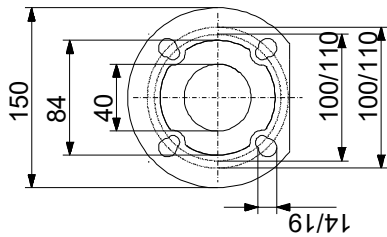

Note! All units are in [mm] unless others are stated.
Disclaimer: This simplified dimensional drawing does not show all details.