

On request MAGNA3 25-40 N

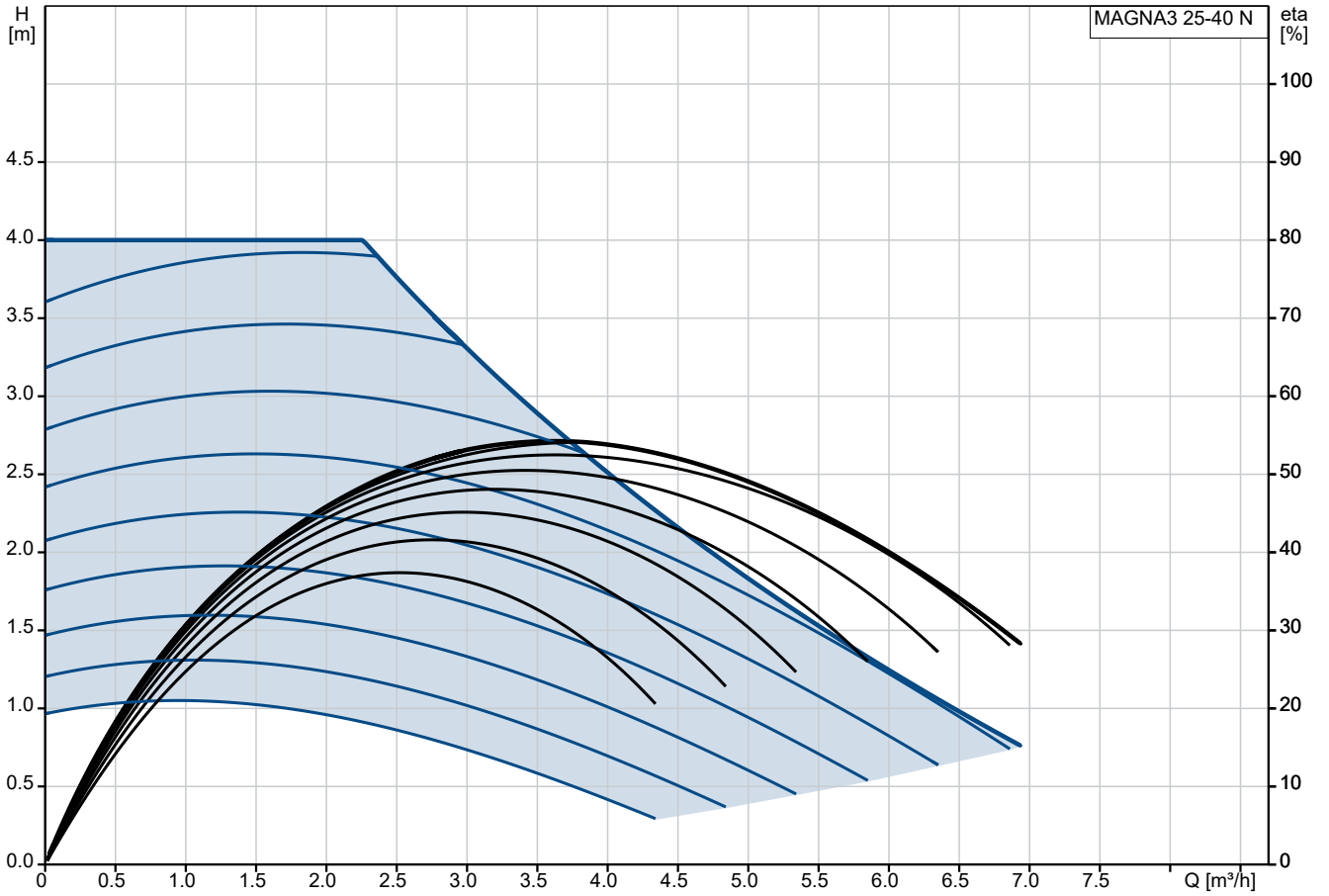

Pumped liquid = Water
 Liquid temperature during operation = 60 °C
 Density = 983.2 kg/m³

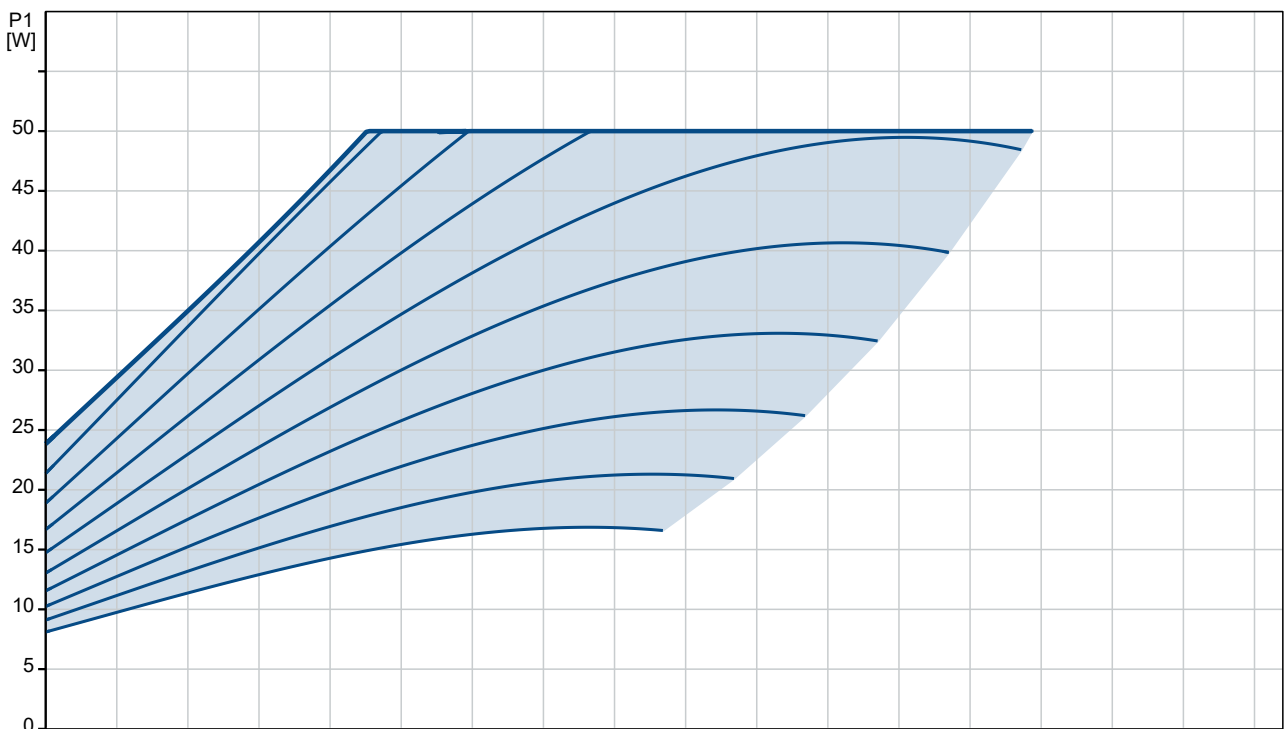

Description	Value
General information:	
Product name:	MAGNA3 25-40 N
Product No:	On request
EAN number:	On request
Technical:	
Rated flow:	3.71 m ³ /h
Rated head:	2.73 m
Head max:	40 dm
TF class:	110
Approvals:	CE, VDE, EAC, MOROCCO, UKCA, TSERCM, UkrSEPRO
Approvals for drinking water:	WRAS, ACS, UBA
Model:	E
Materials:	
Pump housing:	Stainless steel
Pump housing:	EN 1.4308
Pump housing:	ASTM 351 CF8
Impeller:	PES 30%GF
Installation:	
Range of ambient temperature:	0 .. 40 °C
Maximum operating pressure:	10 bar
Pipe connection:	G 1 1/2"
Pressure rating:	PN 10
Port-to-port length:	180 mm
Liquid:	
Pumped liquid:	Water
Liquid temperature range:	-10 .. 110 °C
Selected liquid temperature:	60 °C
Density:	983.2 kg/m ³
Electrical data:	
Power input - P1:	9 .. 50 W
Mains frequency:	50 / 60 Hz
Rated voltage:	1 x 230 V
Maximum current consumption:	0.09 .. 0.46 A
Enclosure class (IEC 34-5):	X4D
Insulation class (IEC 85):	F
Others:	
Energy (EEL):	0.18
Net weight:	5.12 kg
Gross weight:	5.98 kg
Shipping volume:	0.015 m ³
Danish VVS No.:	380795040
Swedish RSK No.:	5803234
Finnish LVI No.:	4615643
Norwegian NRF no.:	9042353
Country of origin:	DE
Custom tariff no.:	84137030
Environmental approvals:	CN ROHS, WEEE

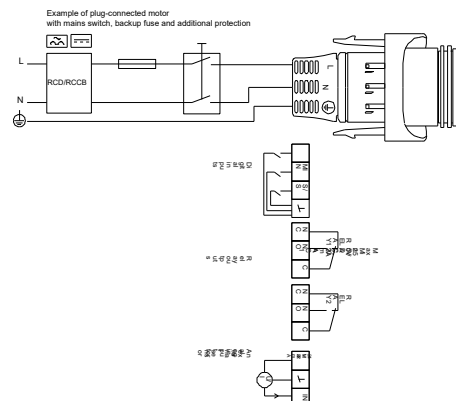
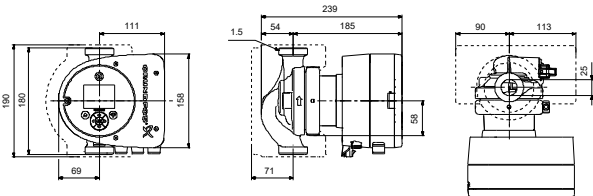
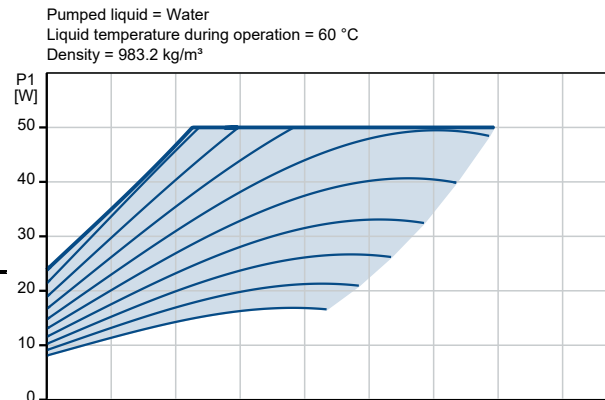
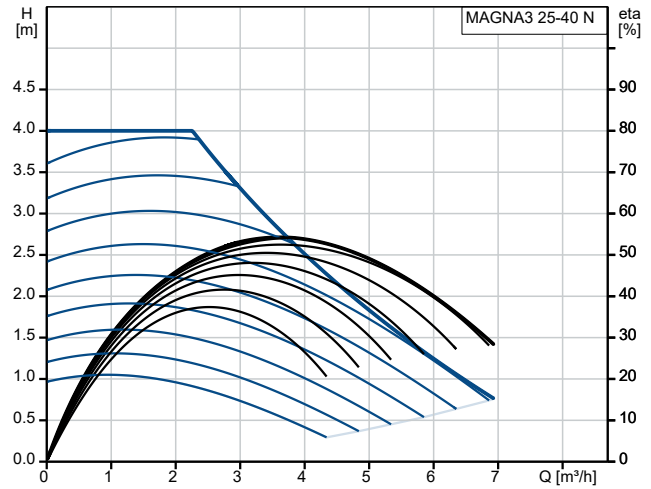

On request MAGNA3 25-40 N

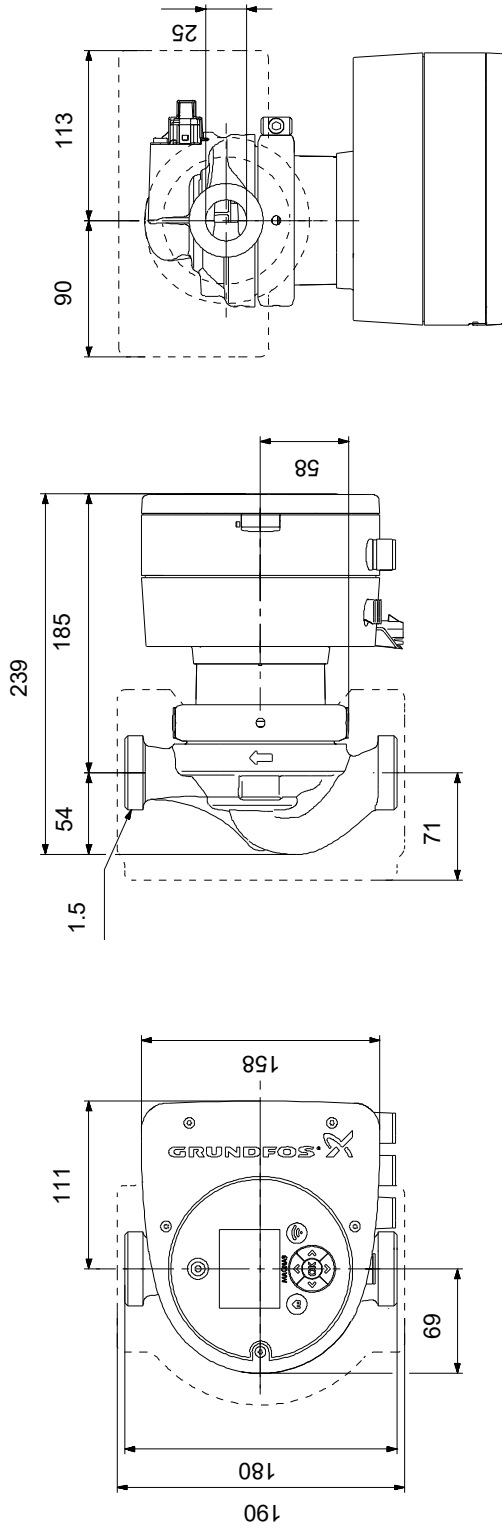

Note! All units are in [mm] unless others are stated.
 Disclaimer: This simplified dimensional drawing does not show all details.

On request MAGNA3 25-40 N

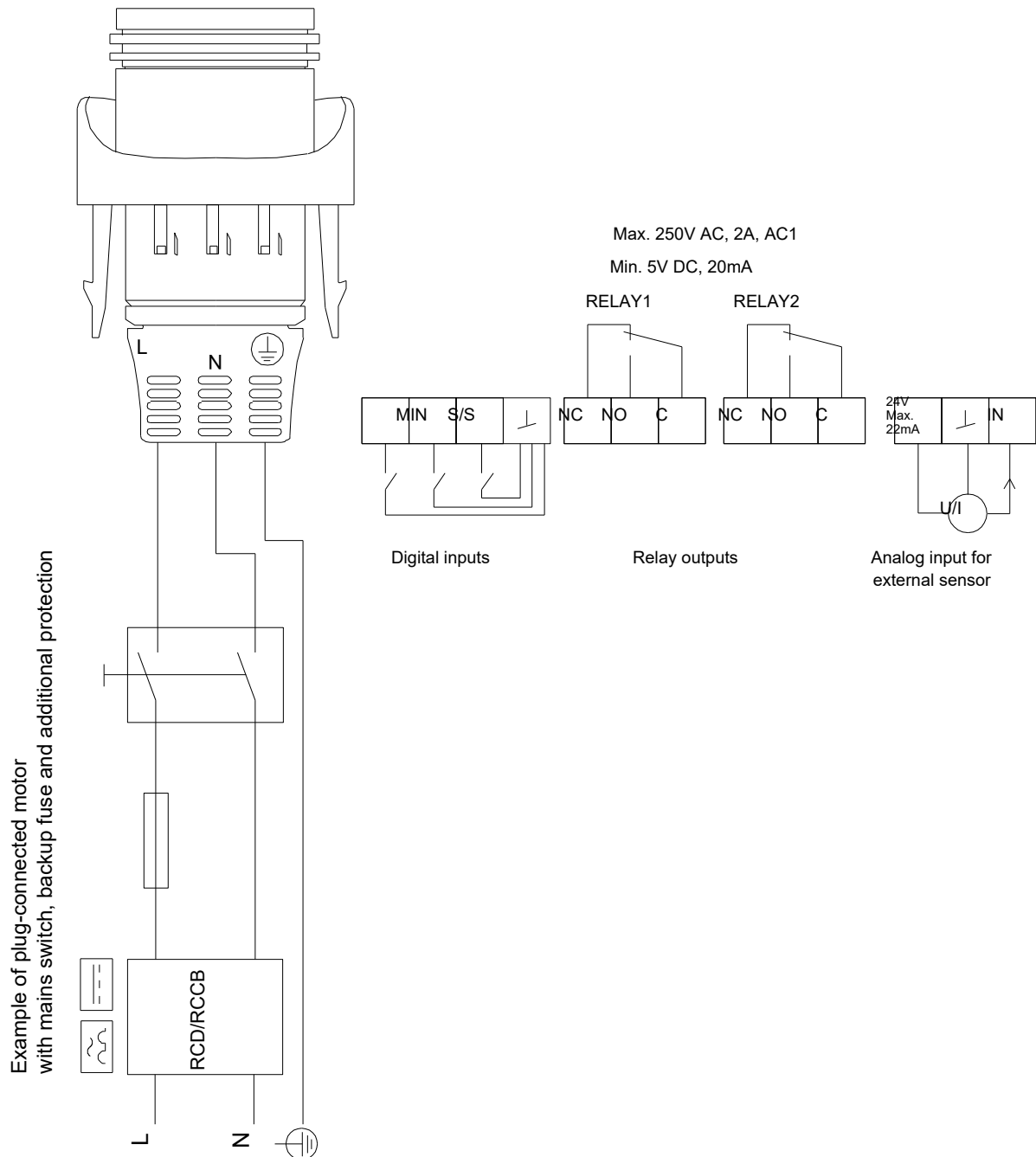

Note! All units are in [mm] unless others are stated.

