

Optimum air and dirt separation combined with energy efficiency.

For use in sealed heating and cooling systems.

Air and dirt separators protect the boilers, pumps and fittings from damage caused by the deposit of dirt particles, increase comfort and improve the yield. Air and dirt separators also offer benefits in the event of application in old systems or when an open system is converted to a closed system.

- Increases comfort and yield.
- Prevents deposit of dirt particles in the boiler.
- The removal of air and dirt from the system water extends the service life of pumps, control equipment and other system accessories.

The new steel Flamcovent Clean Smart air and dirt separators remove even the tiniest microbubbles and minuscule dirt particles from the system water. The Flamco Clean Smart performs 60% better than conventional air and dirt separators whilst the flow resistance has been reduced to a negligible level.

- With flanged connection according to EN 1092-1 PN16.

Advantages

- Up to 60% better performance compared to conventional air and dirt separators.
- Extremely low flow resistance resulting in less energy consumption.
- Standard flow speed up to 3 m/s.
- Twenty-five neodymium supermagnets are incorporated into the dirt scraper.
- Constant performance during the entire lifespan.
- Low maintenance.

Technical Specifications

- Maximum working pressure: 10 bar.
- Models with a maximum working pressure of 25 bar are available upon request.
- Suitable for systems with a maximum flow temperature of 110 °C (DN50, DN65 120 °C).
- Suitable for addition of glycol-based anti-freeze up to 50%.
- Suitable for addition of ethanol-based anti-freeze up to 30%.
- In accordance with Pressure Equipment Directive 2014/68/EU.



Description	Flamcovent Clean Smart F DN100		
Order Code	31045		
GTIN	08712874310452		
Model	<u>Flamcovent Clean Smart F - 10.0 bar</u>		
Capacity [l]	33		
Connection	[DN]	100	
	[mm]	114.3	
Dimensions	A [mm]	795	
	B [mm]	470	
	C [mm]	435	
	D [mm]	270	
Connection Flanges	8		
K_v^* [m ³ /h] ($\Delta P = 1$ bar)	311		
Weight [kg]	32		

* $K_v = Q / \sqrt{\Delta P}$ Q: Flow [m³/h] ΔP: Pressure loss over the product (1 bar)
 Flow factor K_v : Rate of flow [m³/h] which results in a 1 bar pressure drop across the product. This is different then the maximum allowed flow rate of the product.

** 4 hole flanged version.

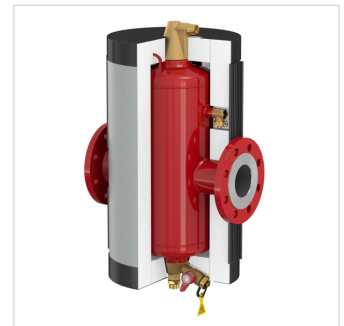
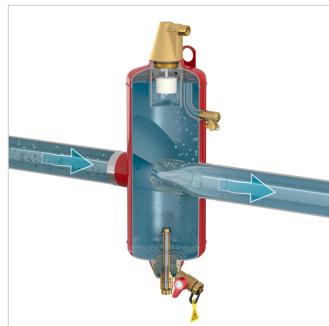
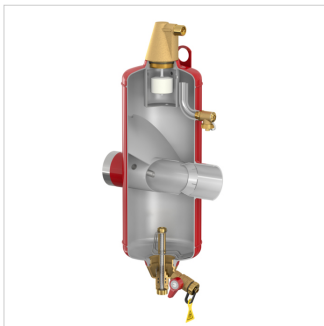
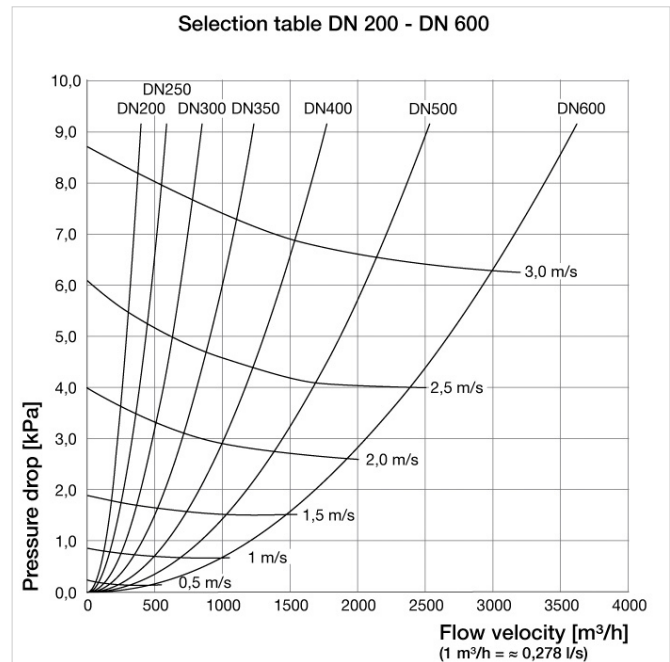
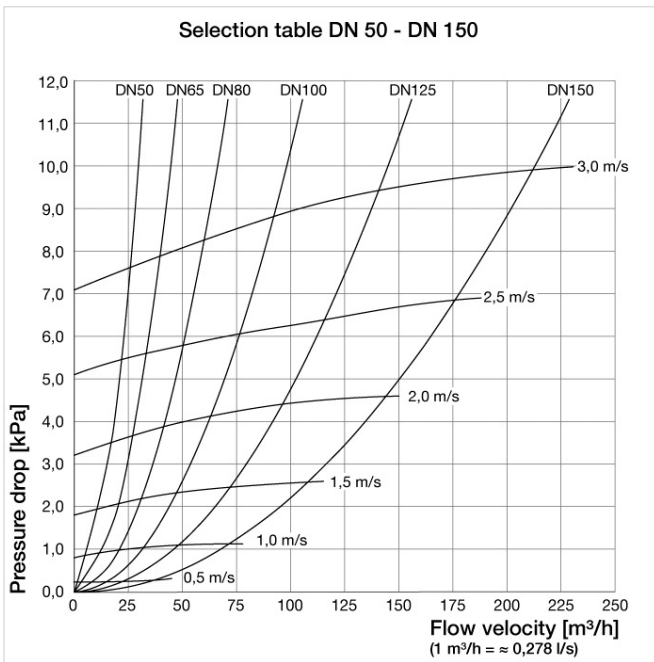
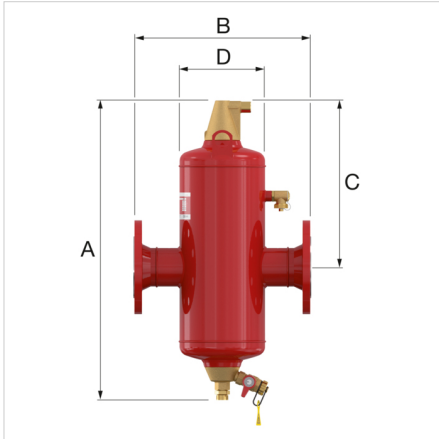

Classification General Data

Etim Group	Filters/separators
Etim Class	Air-/dirt separator
Product Name	Flamcovent Clean Smart F DN100
Brand	FLAMCO
Product Type	Smart Air & Dirt (>=DN50)
Order Code	31045
GTIN	08712874310452

Attributes

Material	Steel
Separator type	Air/dirt
Model	Horizontal
Material of connection	Steel
Material quality connection	Other
Housing material	Steel
Housing material quality	Other
Variable flow direction	No
Suitable for heating	Yes
Suitable for cooling	Yes
Suitable for solar	No
Nominal diameter	DN 100
Outer pipe diameter	114.3 Millimetre
Connection	Flange
Operating principle	Other
Flange standard	DIN
Construction length	470 Millimetre
Article compression class	PN 10
With blow-off valve	Yes
Surface protection	Untreated
Whirl operating principle	No
Negative pressure operating principle	No
Magnet operating principle	Yes
Thrust operating principle	Yes
Partial flow principle	Yes
Principle full flow with settling	No
Max. medium temperature (continuous)	110 Degrees celsius
Cleaning possible during operation	No
Magnet location	Internal
Suitable for open system	No
Suitable for closed system	Yes
Max. operation pressure	10 Bar
With drain valve	Yes
With dismountable filter	No
Filter volume	0 Litre
Filter mesh density	0 Millimetre
Backwash filter	No
Min. pressure for back flush	0 Bar
With automatic de-aerator	Yes
With couplers	No
Inlet/outlet offset distance	0 Millimetre
Medium temperature (continuous)	0 - 110 °C
Max. operating pressure	10 Bar
Kvs value	311
With insulation	No
Heat conduction coefficient insulation material (λ)	0 Watt per metre Kelvin
Max. glycol mixture	50 Percentage

With integrated replenishment automat No

Find more information online:

[Installation and operating instruction](#)

[Statement of Conformity \(<= DN 200\)](#)

[Flamcovent Clean Smart F ADSK](#)

[Flamcovent Clean Smart F DWG](#)

[Flamcovent Clean Smart F IPT](#)

[Flamcovent Clean Smart F STEP](#)

[Smart DN50 - 600 Brochure](#)

[Specification Text](#)

[Packaging data](#)

[Flamcovent & Clean Smart](#)

[Flamcovent & Clean Smart](#)

Fort Blauwkapel 1
1358 DB, Almere - nl

T +31 (0)36 52 62 300

E info@aalberts-hfc.com

I flamcogroup.com