

PROJECT:	UNIT TAG:	QUANTITY:
REPRESENTATIVE: _____	TYPE OF SERVICE:	DATE: _____
ENGINEER:	SUBMITTED BY:	DATE:
CONTRACTOR:	APPROVED BY:	DATE:
	ORDER NO.:	DATE:

## MAGNA3 D 32-100



The MAGNA3 D circulator pump means double the performance and reduced downtime due to the three multipump modes: Alternating, backup and cascade operation. The two pumps communicate wirelessly. The MAGNA3 D is ideal for high-performance heating and cooling applications.

Note! Product picture may differ from actual product

Conditions of Service		Pump Data		Motor Data	
Liquid:	Water	Maximum operating pressure:	10 bar	P1 max:	9 .. 169 W
Temperature:	60 °C	Liquid temperature range:	-10 .. 110 °C	Mains frequency:	50 / 60 Hz
Specific Gravity:	0.985	Maximum ambient temperature:	40 °C	Enclosure class:	X4D
		Pipe connection:	G 2"	Insulation class:	F
		Product number:	On request		

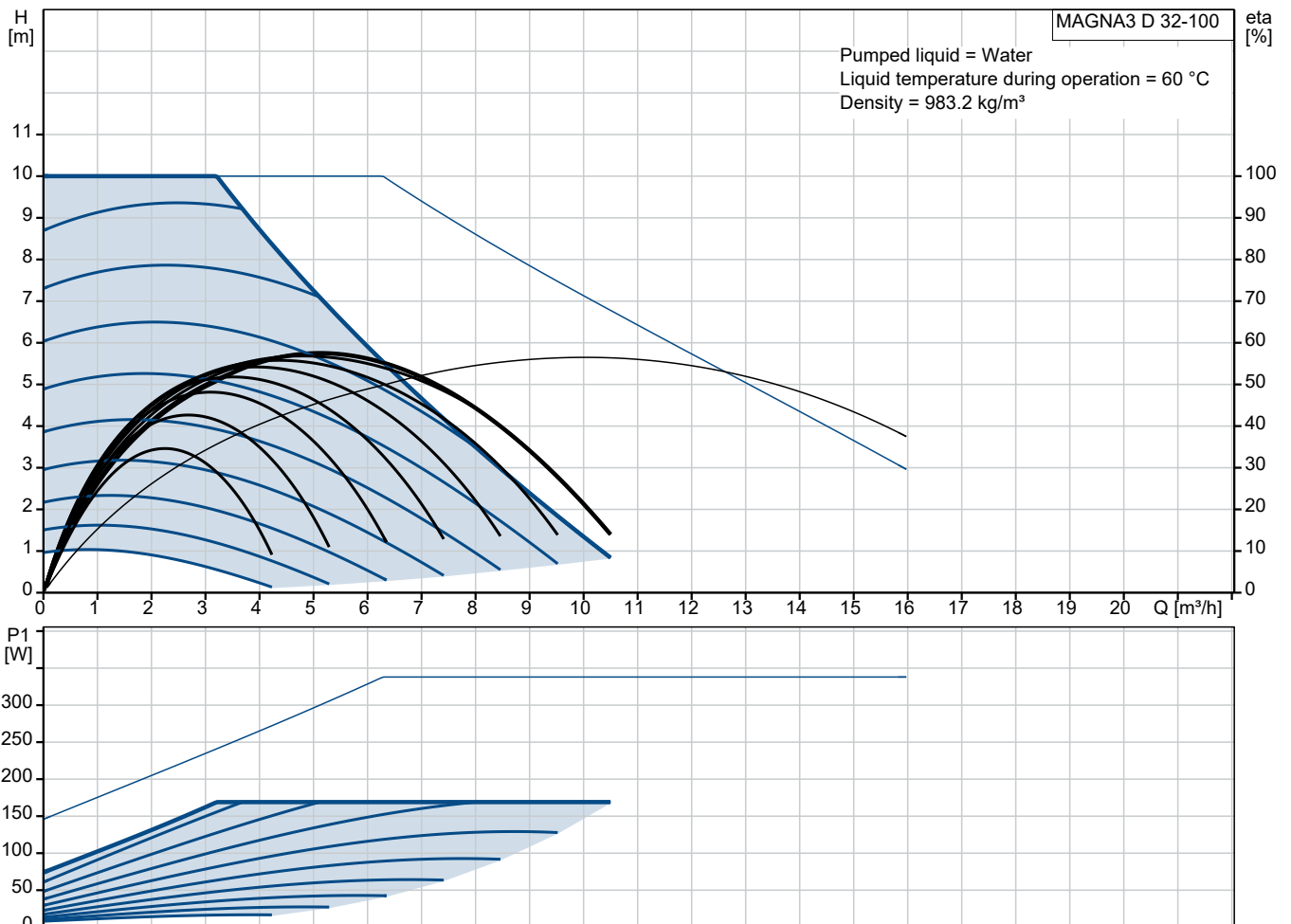

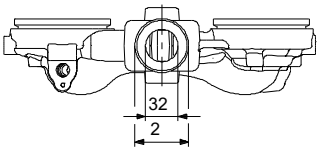
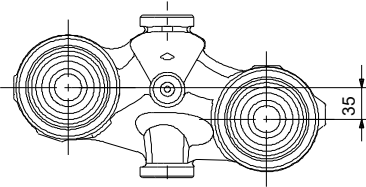
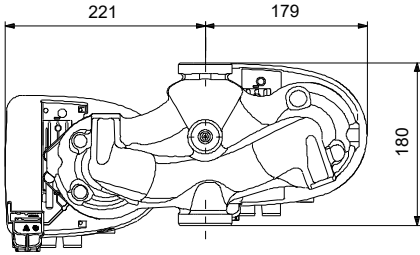
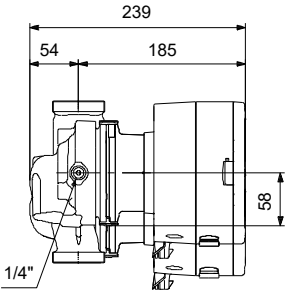
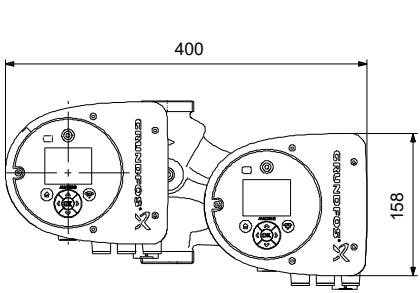

- Materials:**  
 Pump housing: Cast iron  
 Pump housing: EN-GJL-200  
 Pump housing: ASTM A48-200B  
 Impeller: PES 30%GF

Qty. Description

1 MAGNA3 D 32-100



Note! Product picture may differ from actual product

Product No.: On request

The Grundfos MAGNA3 D circulator pump is the ideal choice for almost any building project – old or new. With its unrivalled energy efficiency, all-encompassing range and built-in communication capabilities, MAGNA3 D is ideal for engineers and specifiers looking to create high-performance heating and cooling systems.

The pump is maintenance-free due to the canned-rotor type design. This also means that pump and motor form an integral unit without shaft seal and with only two gaskets for sealing. The bearings are lubricated by the pumped liquid.

MAGNA3 D offers three multipump modes: Alternating, backup and cascade operation.

In alternating and backup operation, only one pump operates at a time, both ensuring constant comfort.

In alternating operation, the change from one pump to the other depends on time or energy.

If a pump fails, the other pump will take over automatically.

In backup operation, the backup pump is operated at intervals to prevent seizing up.

If the duty pump stops due to a fault, the backup pump will start automatically.

In cascade operation, the pumps automatically switch on and off, adapting to the current consumption in the system.

The two pumps communicate wirelessly.

MAGNA3 D features an intuitive display and allows you to connect wirelessly with the Grundfos GO Remote app, giving you access to advanced reporting and monitoring.

MAGNA3 model E has Bluetooth, which allows you to connect directly to Grundfos Go app on your smart phone without any need for a dongle.

The pump includes fieldbus communication via CIM modules as well as analog and digital inputs and configurable relays.

Control features include AUTOADAPT and FLOWADAPT. FLOWADAPT which reduces the need for throttling valves, thus cutting costs on system components.

MAGNA3 D is the superior choice for a wide range of heating and cooling applications, including:

- Mixing loops
- Heating surfaces
- Air conditioning surfaces
- Ground-source heat pump systems
- Smaller chiller applications.

MAGNA3 D is a single-phase pump and characterised by having the controller and display integrated in the control box. The pump also has a built-in differential-pressure and temperature sensor.

The pump housing is available in both cast-iron and stainless-steel versions. The composite rotor can is carbon-fibre reinforced, the bearing plate and rotor cladding are made of stainless steel and the stator housing is made of aluminium. The power electronics are air-cooled.

MAGNA3 incorporates a 4-pole synchronous, permanent-magnet motor (PM motor). This motor type is characterised by higher efficiency than a conventional asynchronous squirrel-cage motor. The pump speed is controlled by an integrated frequency converter.

## On request MAGNA3 D 32-100

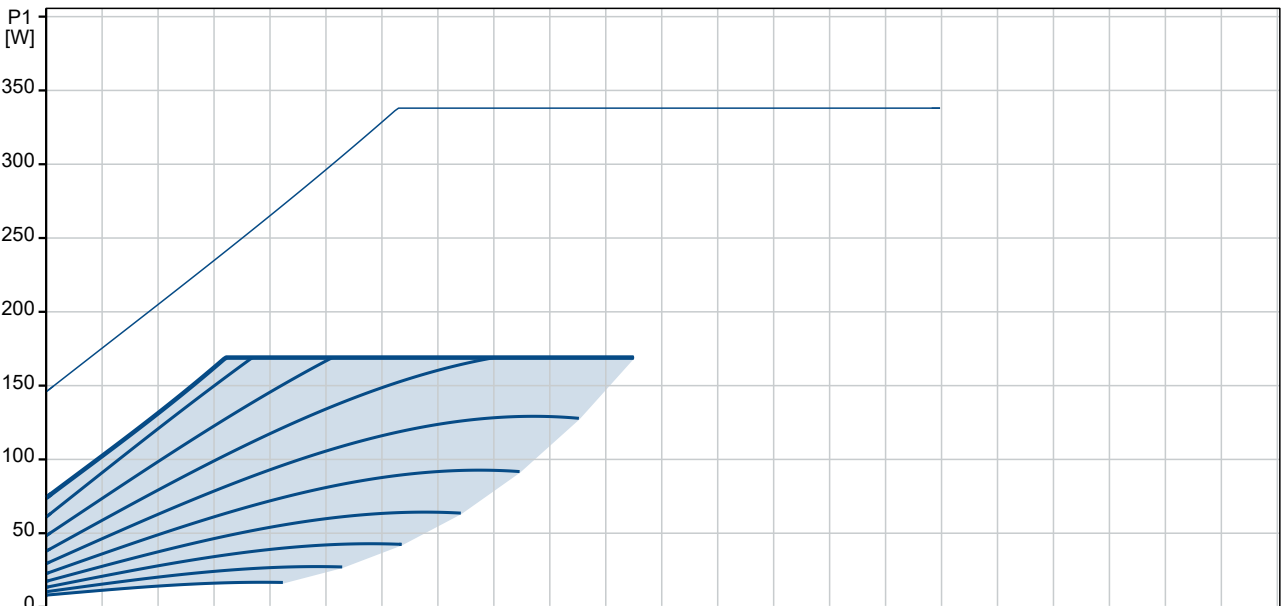
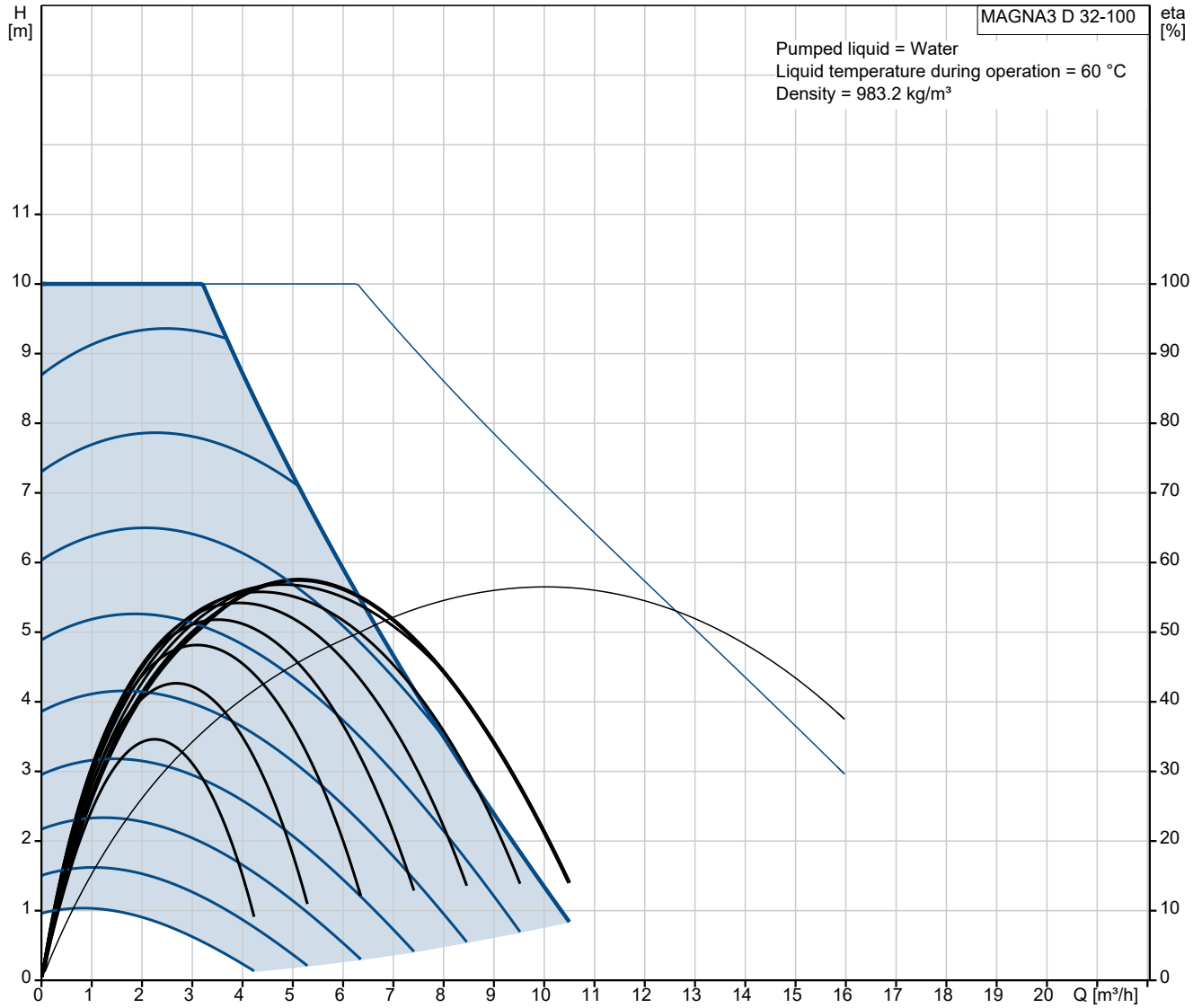

Description	Value
<b>General information:</b>	
Product name:	MAGNA3 D 32-100
Product No:	On request
EAN number:	On request
<b>Technical:</b>	
Rated flow:	4.75 m <sup>3</sup> /h
Rated head:	7.608 m
Head max:	100 dm
TF class:	110
Approvals:	CE, VDE, EAC, MOROCCO, UKCA, TSERCM, UkrSEPRO
Model:	E
<b>Materials:</b>	
Pump housing:	Cast iron
Pump housing:	EN-GJL-200
Pump housing:	ASTM A48-200B
Impeller:	PES 30%GF
<b>Installation:</b>	
Range of ambient temperature:	0 .. 40 °C
Maximum operating pressure:	10 bar
Pipe connection:	G 2"
Pressure rating:	PN 10
Port-to-port length:	180 mm
<b>Liquid:</b>	
Pumped liquid:	Water
Liquid temperature range:	-10 .. 110 °C
Selected liquid temperature:	60 °C
Density:	983.2 kg/m <sup>3</sup>
<b>Electrical data:</b>	
Power input - P1:	9 .. 169 W
Mains frequency:	50 / 60 Hz
Rated voltage [V]:	1 x 230 V
Maximum current consumption:	0.09 .. 1.47 A
Enclosure class (IEC 34-5):	X4D
Insulation class (IEC 85):	F
<b>Others:</b>	
Energy (EEI):	0.18
Net weight:	13.2 kg
Gross weight:	14.6 kg
Shipping volume:	0.055 m <sup>3</sup>
Norwegian NRF no.:	9042345
Country of origin:	DE
Custom tariff no.:	84137030
Environmental approvals:	CN ROHS, WEEE

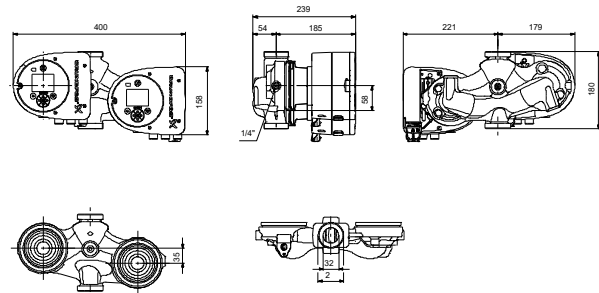
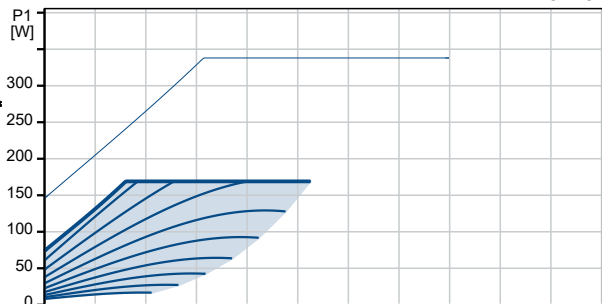
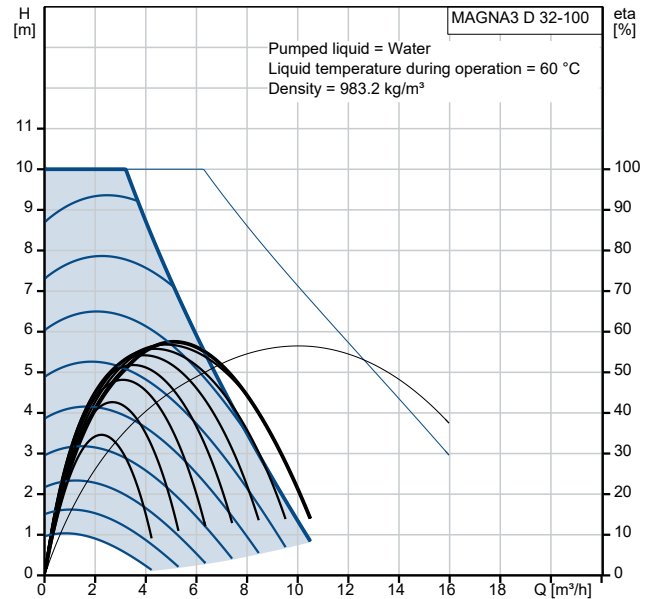

Example of mains-connected motor with mains switch, backup fuse and additional protection

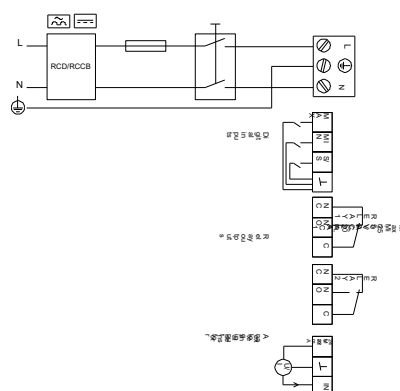

## On request MAGNA3 D 32-100

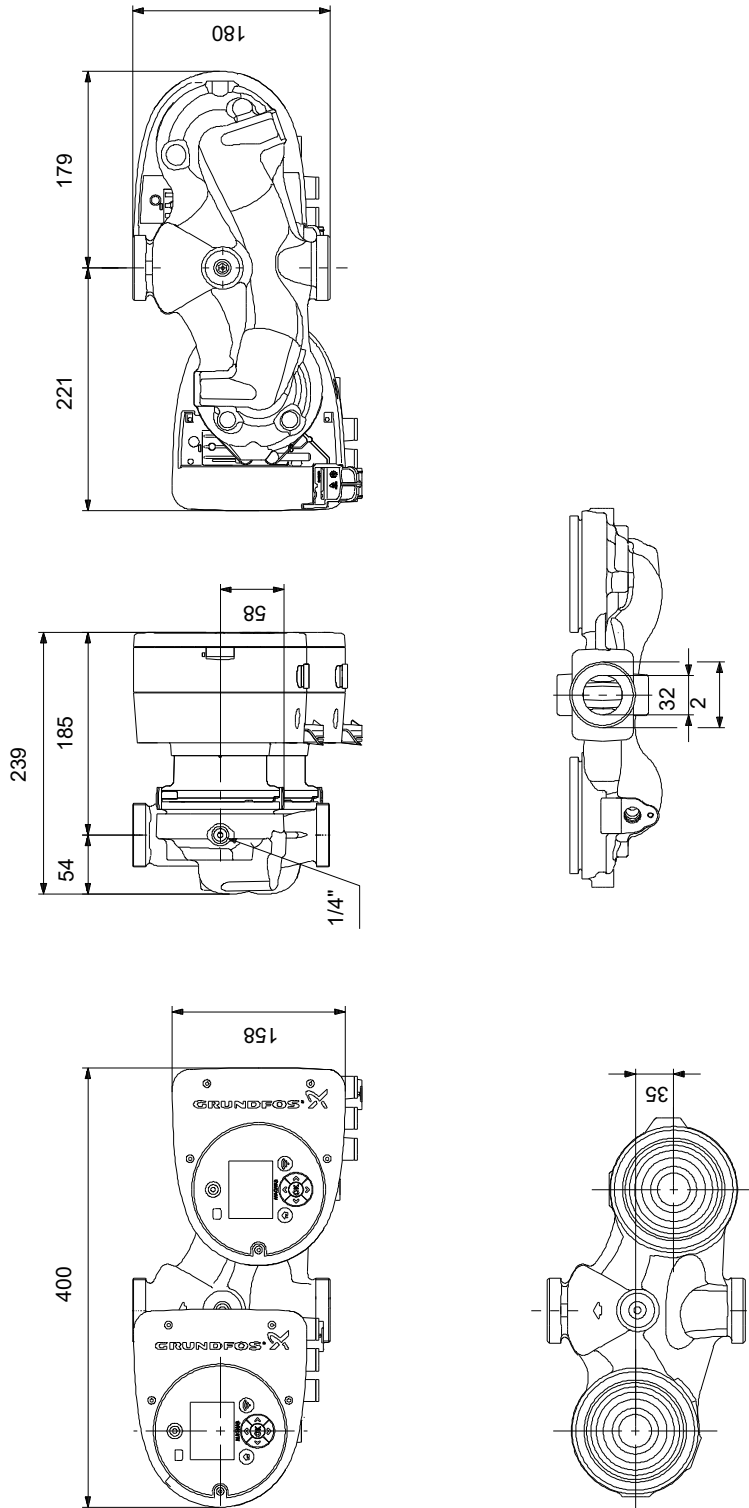

Note! All units are in [mm] unless others are stated.  
Disclaimer: This simplified dimensional drawing does not show all details.

## On request MAGNA3 D 32-100

Example of mains-connected motor with mains switch, backup fuse and additional protection



Note! All units are in [mm] unless others are stated.





( TM058038 Magna3 small)

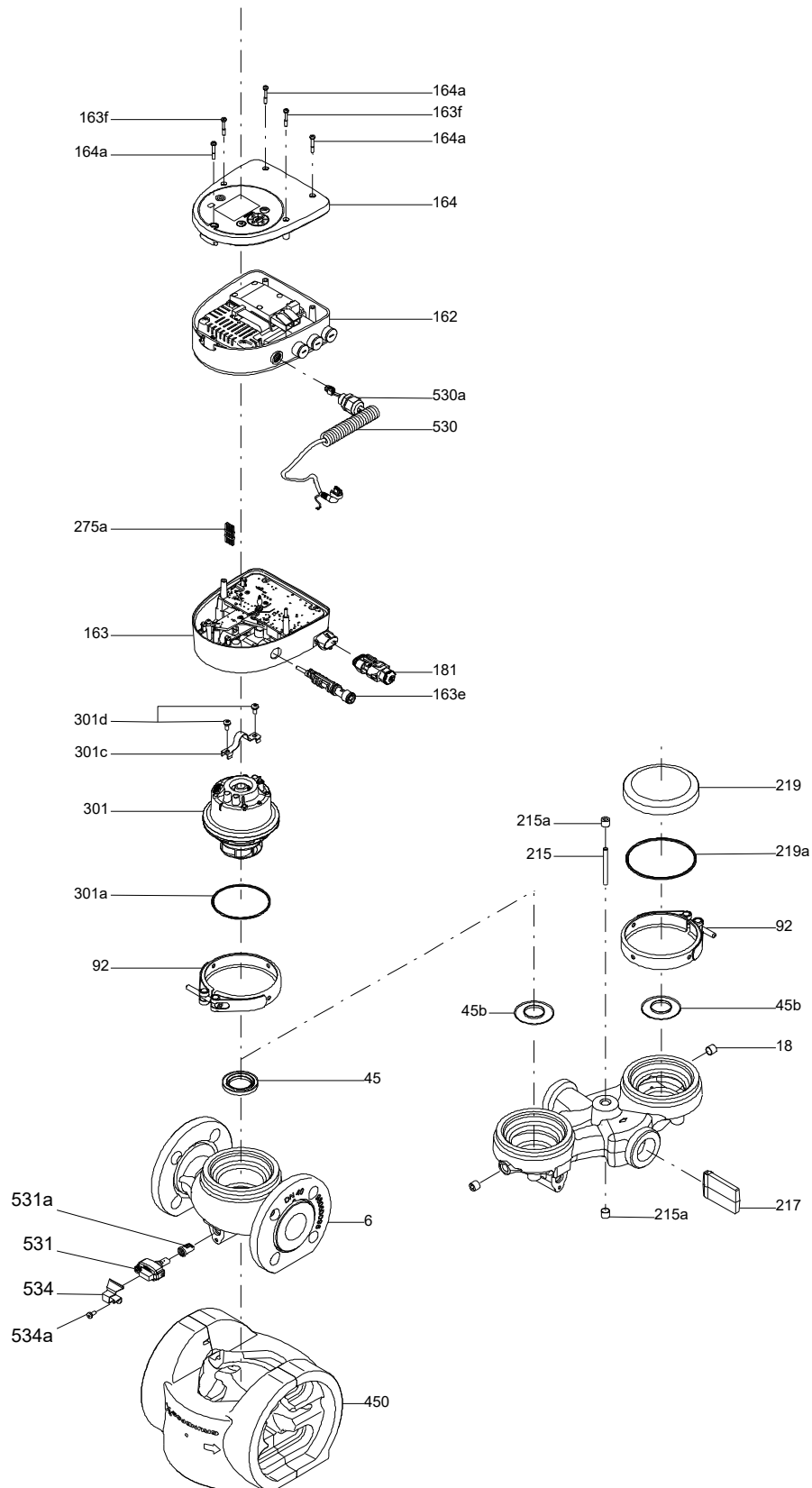

**Spare parts MAGNA3 D 32-100, Product No. On request  
Produced After 1732 (production year and week number)**

Pos	Description	Annotation	Classification Data	Part no.	Qty.	Unit
-	Kit, Control box conf. Head I			99331680	1	pcs
-	Kit,control box non-configured			98148726	1	
-	Control box cpl.					
-	Bottom					
163	Box					
-	Box					
162	Box					
164	Cover cpl.					
530	Cable					
- 531	Sensor					
531a	Sealing cap					
	Conf.				1	
-	Kit, Control box conf. Head II			99332197	1	pcs
-	Kit,control box non-configured			98148726	1	
-	Control box cpl.					
-	Bottom					
163	Box					
-	Box					
162	Box					
164	Cover cpl.					
530	Cable					
- 531	Sensor					
531a	Sealing cap					
	Conf.				1	
-	Kit, Cover			99032834	1	pcs
159a	Cable w/plug				1	
164a	Screw DELTA PT				3	
164a	Screw DELTA PT				2	
164	Cover cpl.				1	
-	Kit, Pump head			98419522	1	pcs
92	Clamp cpl.				1	
- 301	Pump head				1	
-	Stator w/housing cpl.					
301	Stator housing					
303	Rotor can cpl.					
- 304	Shaft w/impeller cpl.					
-	Bearing plate cpl.					
301a	O-ring					
-	Kit, Sensor			99313067	1	pcs
530	Cable				1	
- 531	Sensor				1	
531a	Sealing cap					
534a	Pan head thread forming screw				1	
534	Bracket				1	
-	Kit, Sensor			99313072	1	pcs
530	Cable				10	
- 531	Sensor				10	
531a	Sealing cap					
-	Kit, Valve flap			96407253	1	pcs
215	Guide pin				1	
217	Valve flap				1	
-	Spare, Clamp			98148760	1	pcs
92	Clamp cpl.				1	



Company name:

Created by:

Phone:

Date:

27/09/2022

Pos	Description	Annotation	Classification Data	Part no.	Qty.	Unit
-	Spare, O-ring			98357755	1	pcs
301a	O-ring				1	
-	Spare, Plug			98284561	1	pcs
181	Plug				1	
-	Spare, Sealing cap			98613455	1	pcs
531a	Sealing cap				1	
18	Pipe plug			96547615	2	pcs
45b	Neck ring			99899633	2	pcs
92	Clamp cpl.			98700283	2	pcs
301a	O-ring			92780125	1	pcs
531a	Sealing cap			98708139	1	pcs