

ecocirc XL 50-180 F

Technical data

Company name
Contact
Phone number
e-mail address

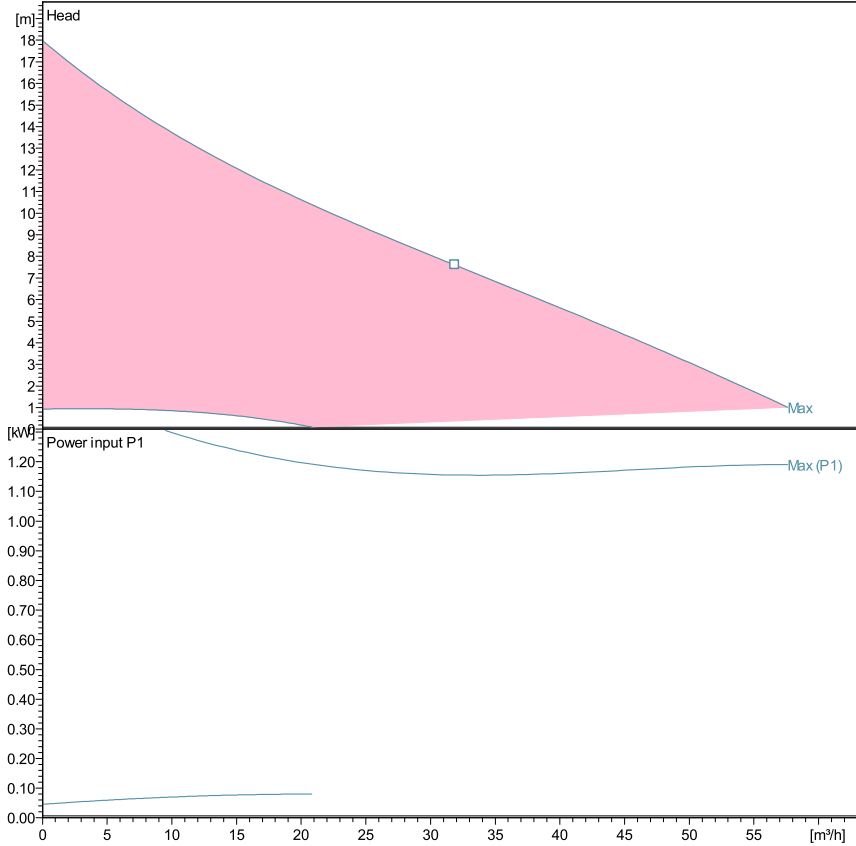

Performance according to ISO 9906:2012 – Grade 3B
Liquid temperature:
-10°C (14°F) to +110 °C (230°F) for heating pumps
-10°C (14°F) to +85 °C (185°F) for domestic hot water pumps
Power data referred to:
Water, pure [100%]; 4°C; 1000kg/m³; 1.57mm²/s



Pump data

Make	Lowara
Port to port (mm)	280
Electrical connection	Terminals
Specific EEI	<= 0,23
Nominal pressure	PN 6/10
Connection	Flanged / DN 50

Electrical data

Rated voltage	230 V
Frequency	50 / 60
Protection class	IP 44
Insulation class	F
Digital input	Contact load: 5V, 10 mA
Digital output	Vmax < 250 VAC / Imax < 2 A
Analog input	0-10 V / 4-20 mA
Leakage current	< 3.5 mA
Communication capabilities	No communication protocol
Sound pressure level	<= 52 dB(A)
Rated current	6.9 A

Materials

Bush Bearing	Carbon, resin impregnated	Impeller	PPS
Thrust bearing	Aluminium	Wear ring	Stainless steel
Bearing plate	Stainless steel	Rotor can	Stainless steel
Motor housing	Aluminum	Shaft	Stainless steel
O-rings	EPDM	Control box	Poly carbonate
PUMP HOUSING	Cast Iron		

Dimensions mm

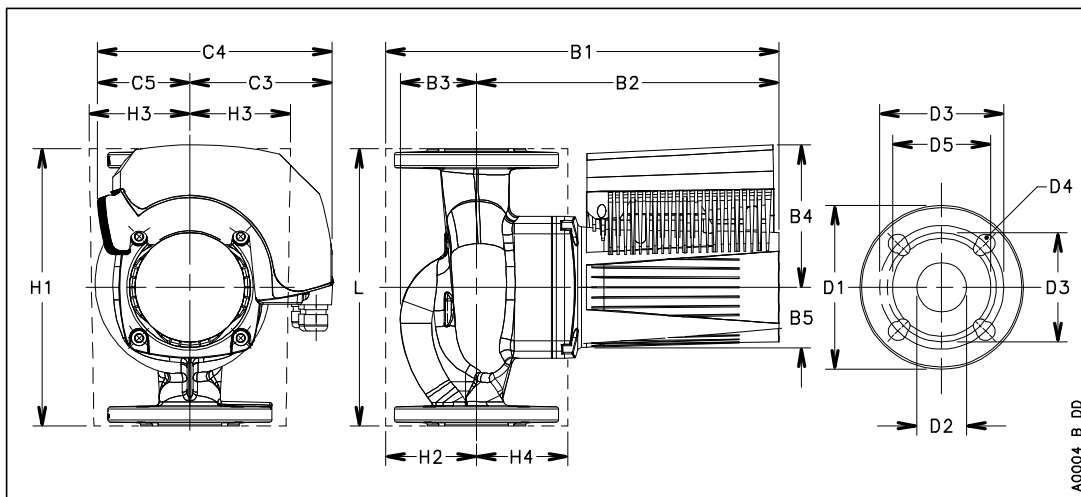

B1	386
B2	314
B3	72
B4	147
B5	61
C3	146
C4	242
C5	96
D1	165
D2	50
D3	110/125
D4	4 x 14/19
D5	99
G	DN 50
Gross Weight	26.4
H1	273
H2	87
H3	107/125
H4	103
L	280
Net Weight	22.6