

ecocirc XL 65-180 F

Technical data

Company name
Contact
Phone number
e-mail address

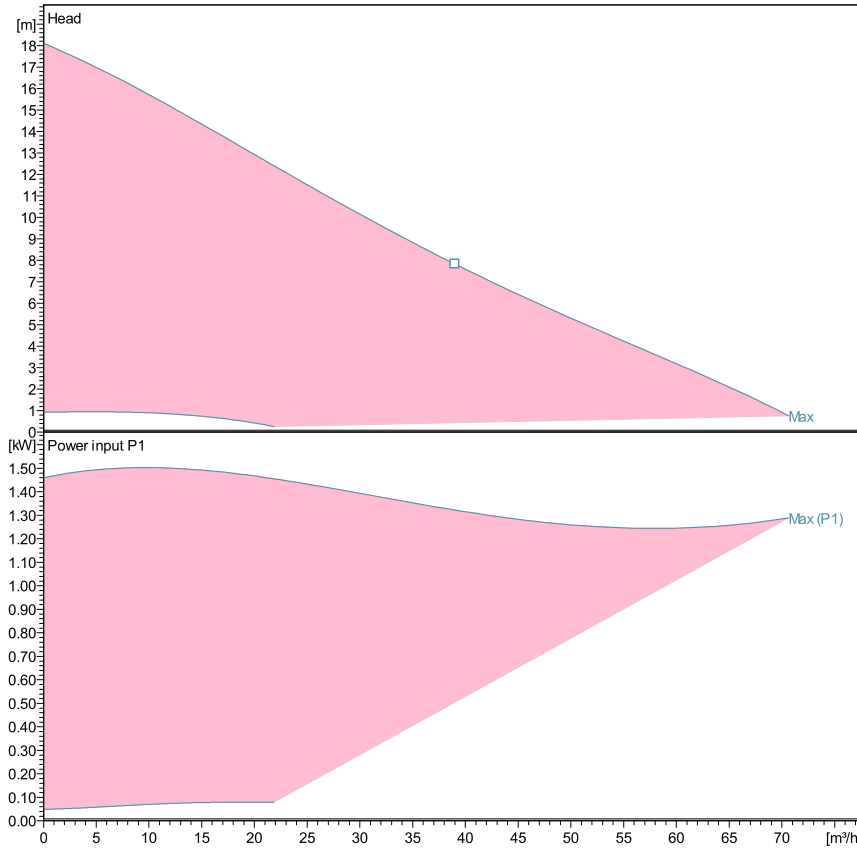

Performance according to ISO 9906:2012 – Grade 3B

Liquid temperature:

-10°C (14°F) to +110 °C (230°F) for heating pumps

-10°C (14°F) to +85 °C (185°F) for domestic hot water pumps

Power data referred to:

Water, pure [100%]; 4°C; 1000kg/m³; 1.57mm²/s



Pump data

Make	Lowara
Port to port (mm)	340
Electrical connection	Terminals
Specific EEI	<= 0,23
Nominal pressure	PN 6/10
Connection	Flanged / DN 65

Electrical data

Rated voltage	230 V
Frequency	50 / 60
Protection class	IP 44
Insulation class	F
Digital input	Contact load: 5V, 10 mA
Digital output	Vmax < 250 VAC / Imax < 2 A
Analog input	0-10 V / 4-20 mA
Leakage current	< 3.5 mA
Communication capabilities	No communication protocol
Sound pressure level	<= 52 dB(A)
Rated current	6.6 A

Materials

Bush Bearing	Carbon, resin impregnated	Impeller	PPS
Thrust bearing	Aluminium	Wear ring	Stainless steel
Bearing plate	Stainless steel	Rotor can	Stainless steel
Motor housing	Aluminum	Shaft	Stainless steel
O-rings	EPDM	Control box	Poly carbonate
PUMP HOUSING	Cast Iron		

Dimensions mm

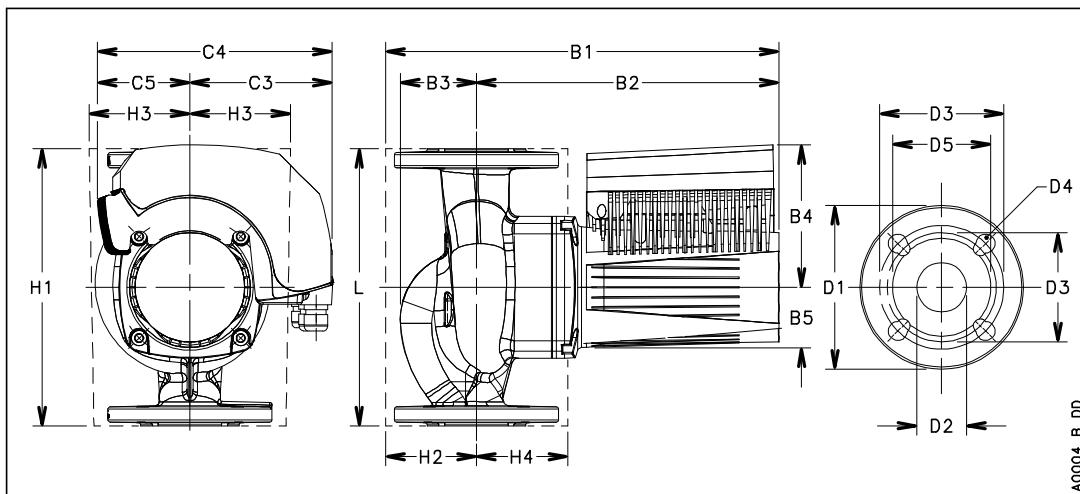

B1	397
B2	316
B3	81
B4	147
B5	61
C3	146
C4	242
C5	96
D1	185
D2	65
D3	145/185
D4	4 x 14/19
D5	118
G	DN 65
Gross Weight	29.5
H1	340
H2	101
H3	107/127
H4	107
L	340
Net Weight	25.7