

Qty. Description

1 TP 50-710/2 A-F-A-BQQE-OW1

Note! Product picture may differ from actual product

Product No.: [96087201](#)

Single-stage, close-coupled, volute pump with in-line suction and discharge ports of identical diameter. The pump is of the top-pull-out design, i.e. the power head (motor, pump head and impeller) can be removed for maintenance or service while the pump housing remains in the pipework.

The pump is fitted with an unbalanced rubber bellows seal. The shaft seal is according to EN 12756. Pipework connection is via PN 16 DIN flanges (EN 1092-2 and ISO 7005-2).

The pump is fitted with a fan-cooled asynchronous motor.

Controls:

Frequency converter: None

Liquid:

Pumped liquid: Water

Liquid temperature range: -25 .. 120 °C

Selected liquid temperature: 20 °C

Density: 998.2 kg/m³
Technical:

Pump speed on which pump data are based: 2945 rpm

Rated flow: 53.9 m³/h

Rated head: 58.6 m

Actual impeller diameter: 230 mm

Code for shaft seal: BQQE

Curve tolerance: ISO9906:2012 3B

Materials:

Pump housing: Cast iron
EN-GJL-250
ASTM class 35

Impeller: Cast iron
EN-GJL-200
ASTM class 30

Installation:

Range of ambient temperature: -30 .. 60 °C

Maximum operating pressure: 16 bar

Max pressure at stated temp: 16 bar / 120 °C

Type of connection: DIN

Size of connection: DN 50

Pressure rating for connection: PN 16

Port-to-port length: 440 mm

Flange size for motor: FF300

Electrical data:

Motor type: 160MD

Qty.	Description
------	-------------

1	Rated power - P2: 15 kW Mains frequency: 50 Hz Rated voltage: 3 x 380-415D/660-690Y V Rated current: 28,0-26,0/16,2-15,6 A Starting current: 660-780 % Cos phi - power factor: 0.89-0.87 Rated speed: 2930-2950 rpm IE Efficiency class: IE3 Motor efficiency at full load: 91.9-91.9 % Motor efficiency at 3/4 load: 92.4-92.7 % Motor efficiency at 1/2 load: 92.4-92.3 % Number of poles: 2 Enclosure class (IEC 34-5): 55 Dust/Jetting Insulation class (IEC 85): F Motor No: 87420022 Others: Minimum efficiency index, MEI \geq : 0.70 Net weight: 165 kg Gross weight: 202 kg Shipping volume: 0.56 m ³ Danish VVS No.: 381703710 Finnish LVI No.: 4616064 Country of origin: HU Custom tariff no.: 84137051
---	---

96087201 TP 50-710/2 A-F-A-BQQE-OW1 50 Hz

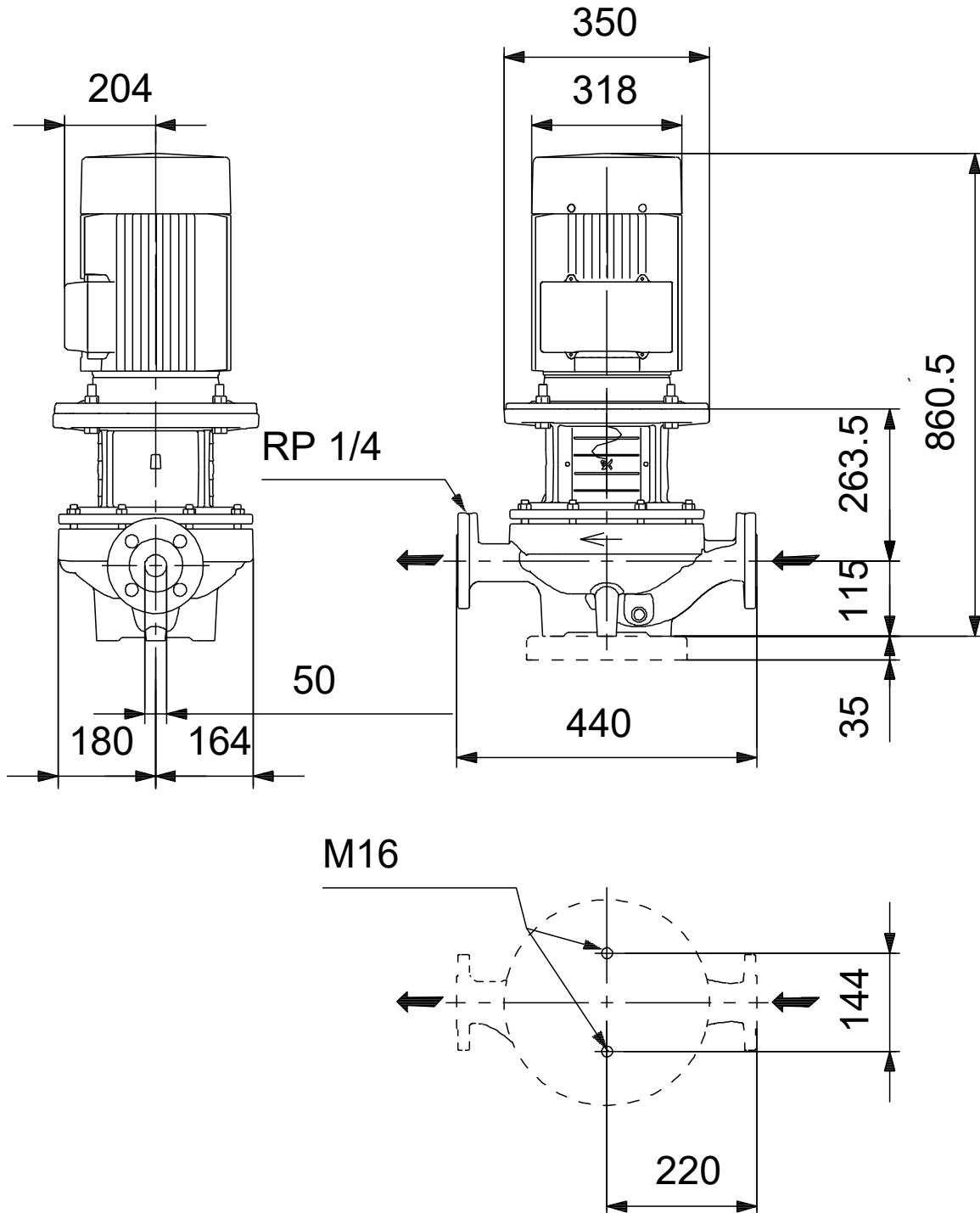

Note! All units are in [mm] unless others are stated.
Disclaimer: This simplified dimensional drawing does not show all details.