

Qty. Description

1 TP 50-120/4 A-F-A-BQQE-GW3



Note! Product picture may differ from actual product

Product No.: [98742942](#)

Single-stage, close-coupled, volute pump with in-line suction and discharge ports of identical diameter. The pump is of the top-pull-out design, i.e. the power head (motor, pump head and impeller) can be removed for maintenance or service while the pump housing remains in the pipework.

The pump is fitted with an unbalanced rubber bellows seal. The shaft seal is according to EN 12756. Pipework connection is via PN 16 DIN flanges (EN 1092-2 and ISO 7005-2).

The pump is fitted with a fan-cooled asynchronous motor.

Controls:

Frequency converter: None

Liquid:

Pumped liquid: Water
 Liquid temperature range: -25 .. 120 °C
 Selected liquid temperature: 20 °C
 Density: 998.2 kg/m³

Technical:

Pump speed on which pump data are based: 1450 rpm
 Rated flow: 22.9 m³/h
 Rated head: 9.77 m
 Actual impeller diameter: 198 mm
 Code for shaft seal: BQQE
 Curve tolerance: ISO9906:2012 3B2

Materials:

Pump housing: Cast iron
 EN-GJL-250
 ASTM class 35
 Impeller: Cast iron
 EN-GJL-200
 ASTM class 30

Installation:

Range of ambient temperature: -20 .. 55 °C
 Maximum operating pressure: 16 bar
 Max pressure at stated temp: 16 bar / 120 °C
 Type of connection: DIN
 Size of connection: DN 50
 Pressure rating for connection: PN 16
 Port-to-port length: 440 mm
 Flange size for motor: FF165

Electrical data:

Motor type: SIEMENS

Qty. Description

1	<p>Rated power - P2: 1.1 kW</p> <p>Mains frequency: 50 Hz</p> <p>Rated voltage: 3 x 220-240D/380-420Y V</p> <p>Rated current: 4.2/2.4 A</p> <p>Starting current: 690-690 %</p> <p>Cos phi - power factor: 0.78</p> <p>Rated speed: 1440 rpm</p> <p>IE efficiency: IE3 84,1%</p> <p>IE Efficiency class: IE3</p> <p>Motor efficiency at full load: 84.1-84.1 %</p> <p>Motor efficiency at 3/4 load: 84.7-84.7 %</p> <p>Motor efficiency at 1/2 load: 83.4-83.4 %</p> <p>Number of poles: 4</p> <p>Enclosure class (IEC 34-5): IP55</p> <p>Insulation class (IEC 85): F</p> <p>Motor No: 83V02205</p> <p>Others:</p> <p>Minimum efficiency index, MEI \geq: 0.70</p> <p>Net weight: 62.1 kg</p> <p>Gross weight: 81 kg</p> <p>Shipping volume: 0.39 m³</p> <p>Danish VVS No.: 381713120</p> <p>Finnish LVI No.: 4616050</p> <p>Norwegian NRF no.: 9043562</p> <p>Country of origin: HU</p> <p>Custom tariff no.: 84137051</p>
---	---

98742942 TP 50-120/4 A-F-A-BQQE-GW3 50 Hz

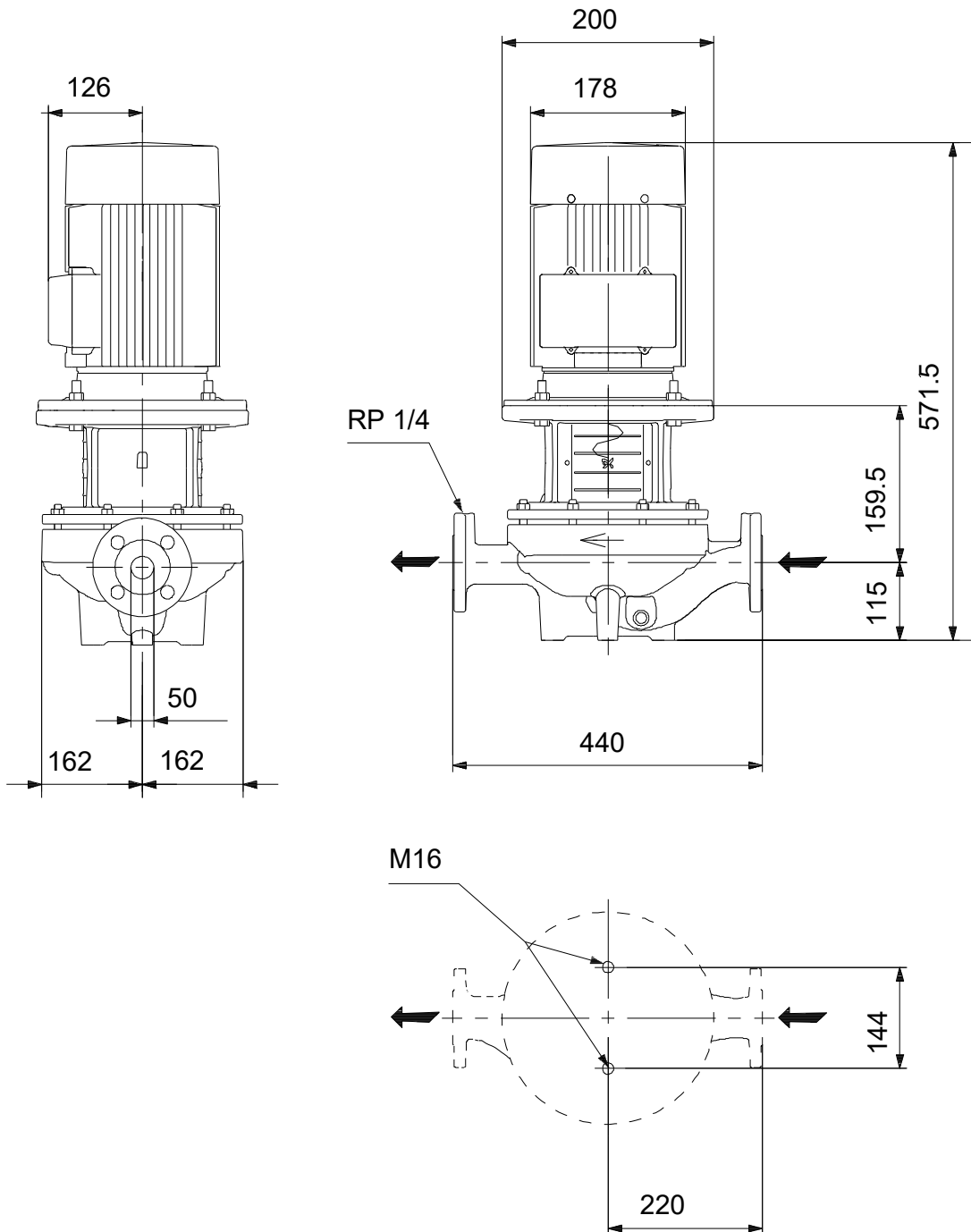

Note! All units are in [mm] unless others are stated.
Disclaimer: This simplified dimensional drawing does not show all details.