

PROJECT: _____	UNIT TAG: _____	QUANTITY: _____
REPRESENTATIVE: _____	TYPE OF SERVICE: _____	DATE: _____
ENGINEER: _____	SUBMITTED BY: _____	DATE: _____
CONTRACTOR: _____	APPROVED BY: _____	DATE: _____
	ORDER NO.: _____	DATE: _____



MAGNA1 32-60

The Grundfos MAGNA1 circulator pump is ideal for basic performance needs in heating and cooling applications. The pump offers basic system control and monitoring and can communicate via a fault relay and digital start/stop.

Note! Product picture may differ from actual product

Conditions of Service		Pump Data		Motor Data	
Liquid:	Water	Maximum operating pressure:	10 bar	P1 max:	9 .. 111 W
Temperature:	60 °C	Liquid temperature range:	-10 .. 110 °C	Mains frequency:	50 / 60 Hz
Specific Gravity:	0.985	Maximum ambient temperature:	40 °C	Enclosure class:	X4D
		Pipe connection:	G 2"	Insulation class:	F
		Product number:	On request		

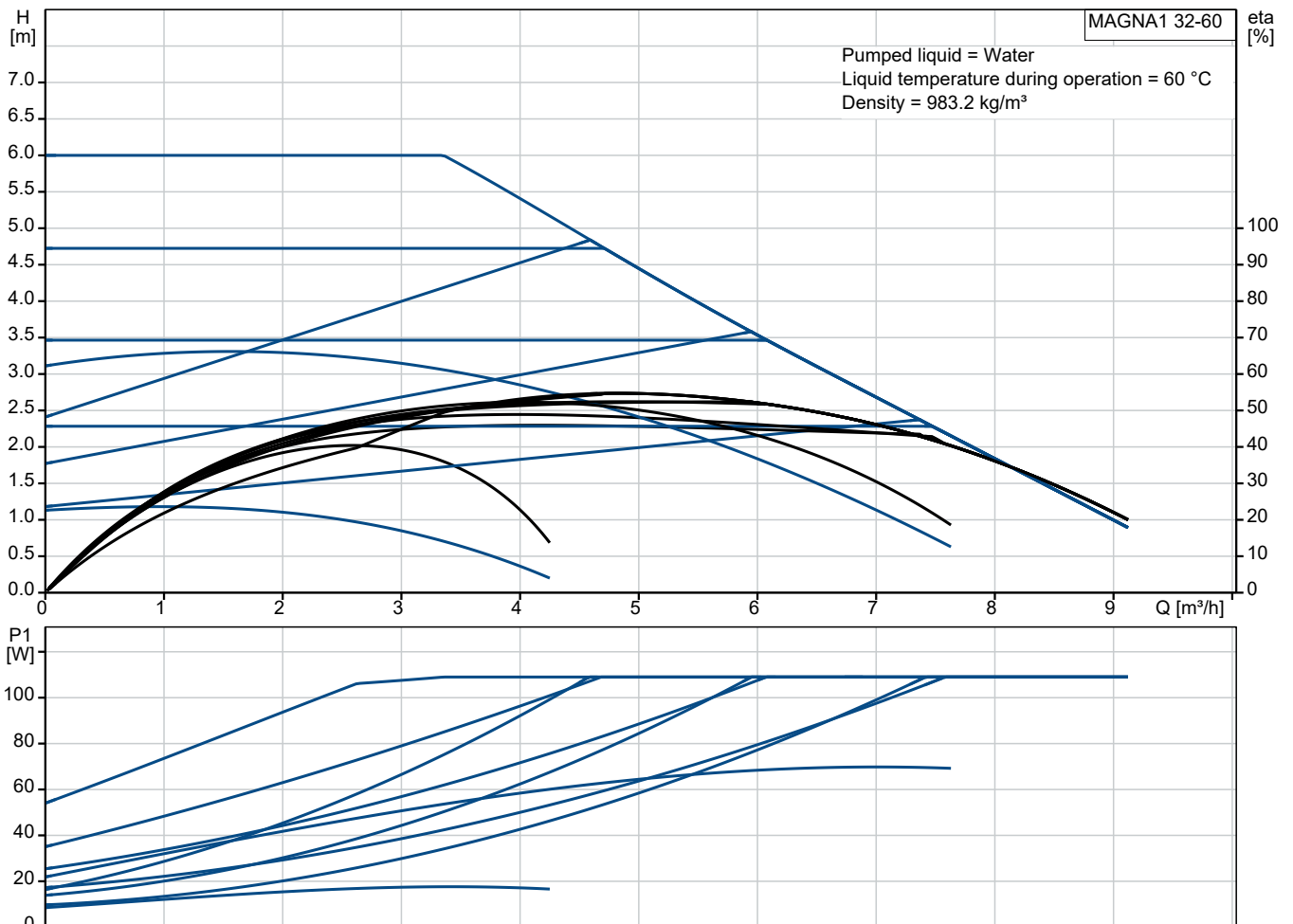

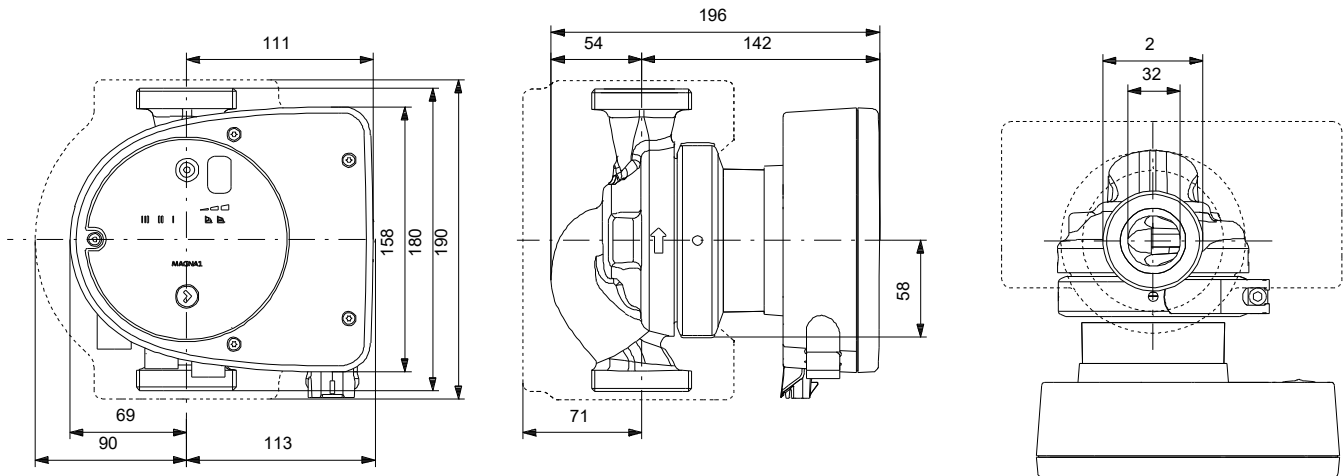

Materials:

- Pump housing: Cast iron
- Pump housing: EN-GJL-200
- Pump housing: ASTM A48-200B
- Impeller: PES 30%GF

Qty.	Description
------	-------------

1	MAGNA1 32-60
---	--------------



Note! Product picture may differ from actual product

Product No.: On request

The Grundfos MAGNA1 circulator pump is the simple option for a job well done.

With its high energy efficiency the product lives up to the EuP 2015 regulations ensuring substantial savings on electricity, and with its intuitive, user-friendly interface and maintenance-free design, MAGNA1 is the ideal circulator pump for basic performance needs in applications where basic system control and monitoring are desired.

With this range of circulator pumps, everything from setup to basic control and monitoring are made easy. The pump is maintenance-free due to the canned-rotor type design.

MAGNA1 offers the possibility of monitoring the pump via the fault relay output. The digital start/stop input remotely controls the pump.

The pump communicates wirelessly with the Grundfos GO Remote app.

MAGNA1 can work as main pump in both heating and cooling applications, including:

- Mixing loops
- Heating surfaces
- Air-conditioning surfaces
- Ground-source heat pump systems
- Smaller chiller applications.

MAGNA1 is a single-phase pump and characterised by having the controller and operating panel integrated in the control box.

The pump housing is available in both cast-iron and stainless-steel versions.

The composite rotor can is carbon-fibre reinforced, the bearing plate and rotor cladding are made of stainless steel and the stator housing is made of aluminium.

The power electronics are air-cooled.

The pump incorporates a 4-pole synchronous, permanent-magnet motor (PM motor). This motor type is characterised by higher efficiency than a conventional asynchronous squirrel-cage motor. The pump speed is controlled by an integrated frequency converter.

On request MAGNA1 32-60

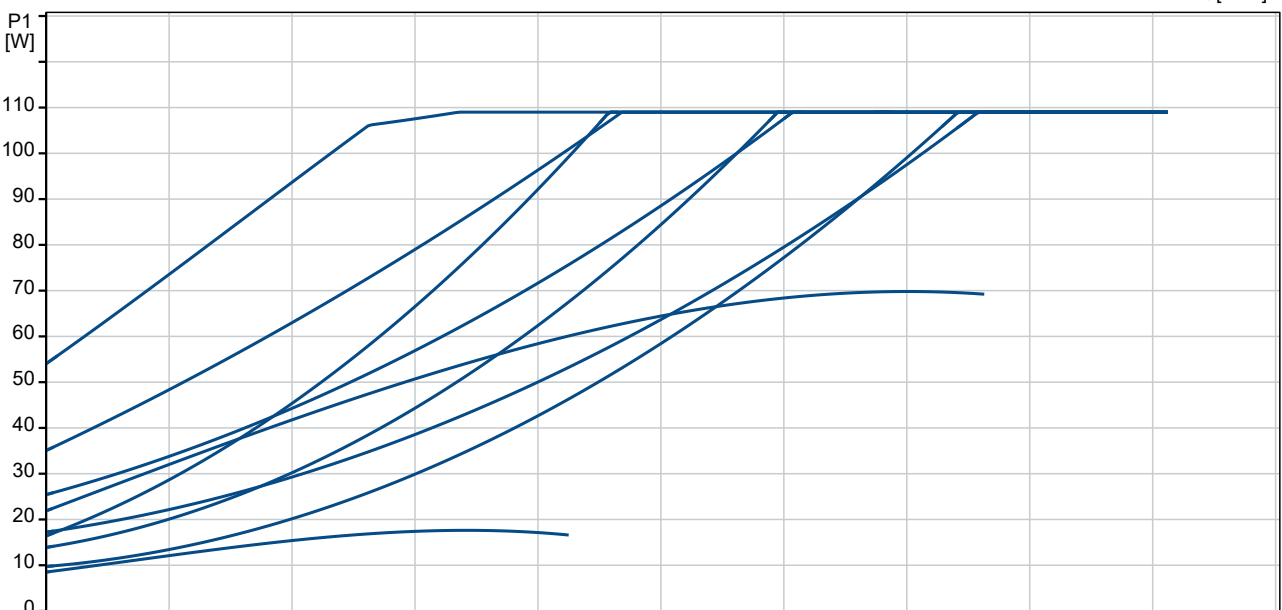
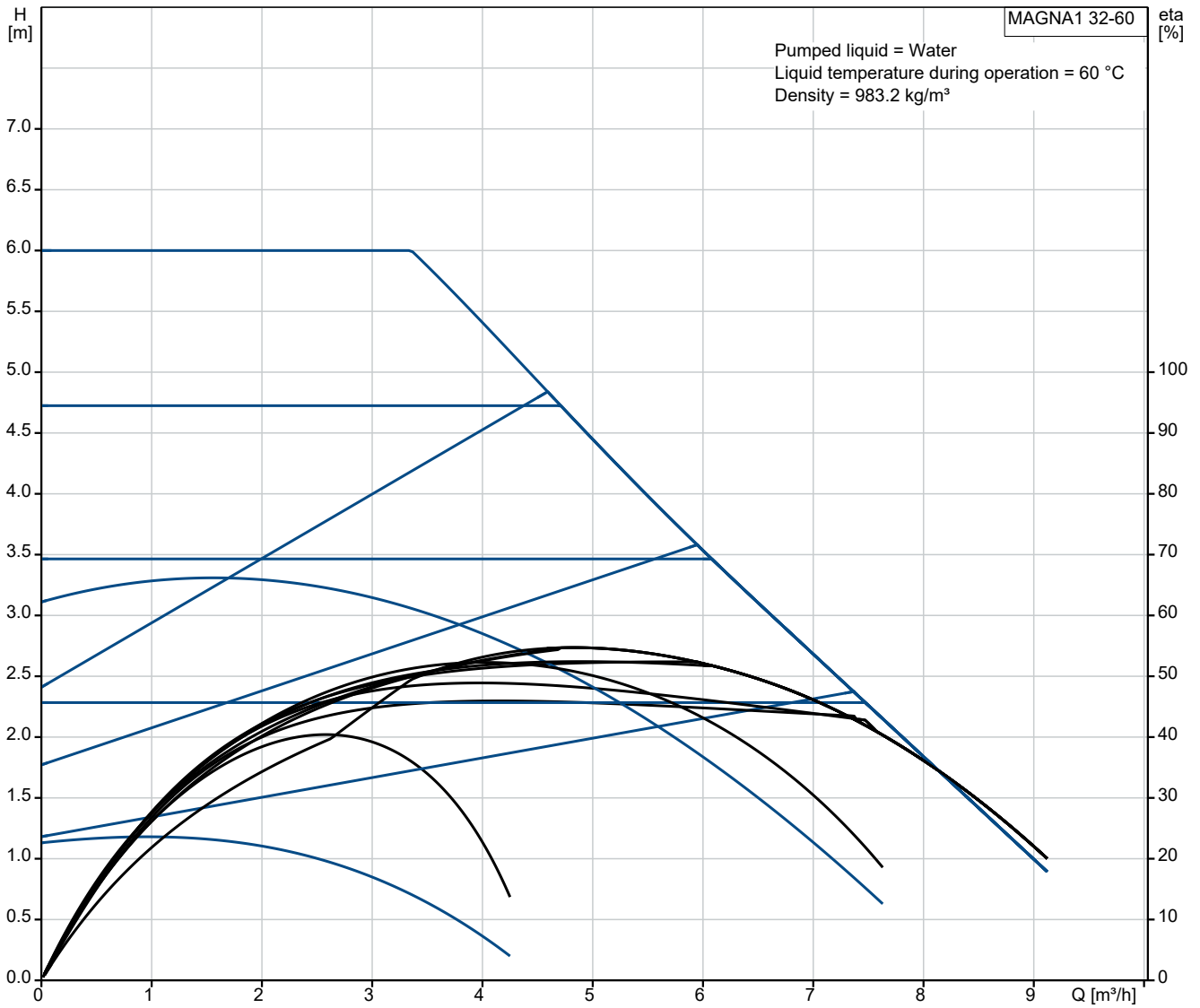

Description	Value
General information:	
Product name:	MAGNA1 32-60
Product No:	On request
EAN number:	On request
Technical:	
Head max:	60 dm
TF class:	110
Approvals:	CE,VDE,EAC,MOROCCO,UKCA, TSERCM,UkrSEPRO
Model:	C
Materials:	
Pump housing:	Cast iron
Pump housing:	EN-GJL-200
Pump housing:	ASTM A48-200B
Impeller:	PES 30%GF
Installation:	
Range of ambient temperature:	0 .. 40 °C
Maximum operating pressure:	10 bar
Pipe connection:	G 2"
Pressure rating:	PN 10
Port-to-port length:	180 mm
Liquid:	
Pumped liquid:	Water
Liquid temperature range:	-10 .. 110 °C
Selected liquid temperature:	60 °C
Density:	983.2 kg/m ³
Electrical data:	
Power input - P1:	9 .. 111 W
Mains frequency:	50 / 60 Hz
Rated voltage [V]:	1 x 230 V
Maximum current consumption:	0.09 .. 0.9 A
Enclosure class (IEC 34-5):	X4D
Insulation class (IEC 85):	F
Others:	
Energy (EEL):	0.20
Environmental approvals:	CN ROHS,WEEE
Net weight:	4.61 kg
Gross weight:	5.1 kg
Shipping volume:	0.013 m ³
Finnish LVI No.:	4615305
Country of origin:	DE
Custom tariff no.:	84137030

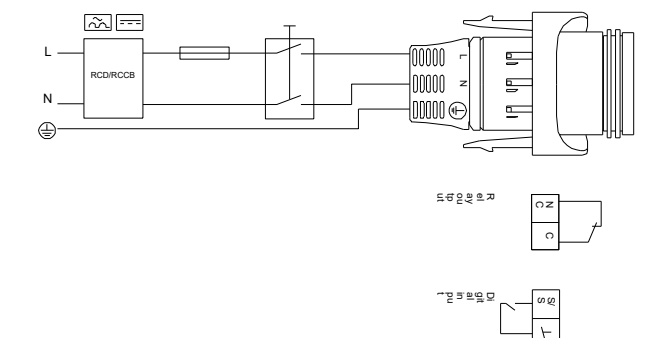
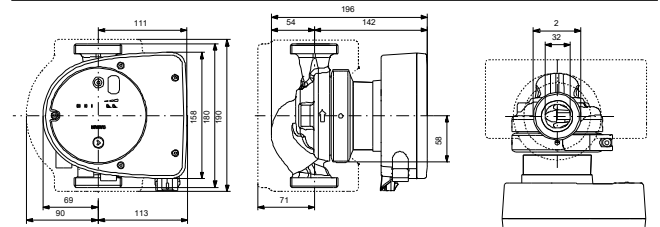
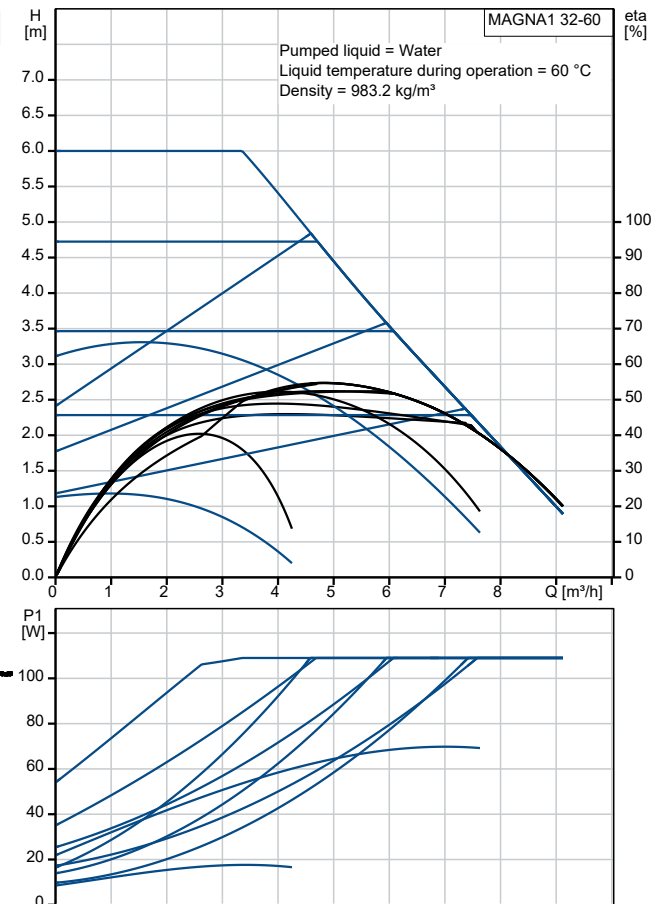

On request MAGNA1 32-60

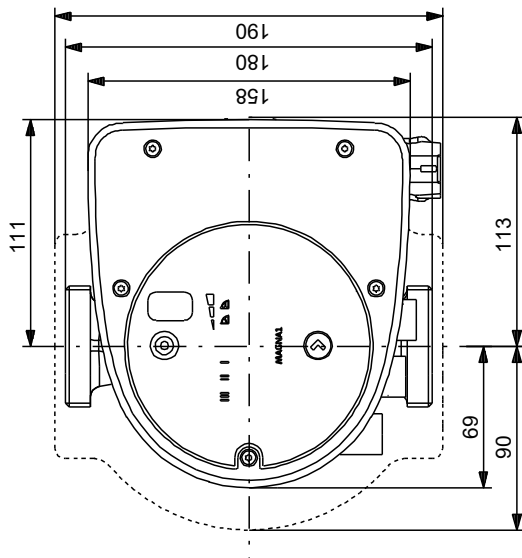
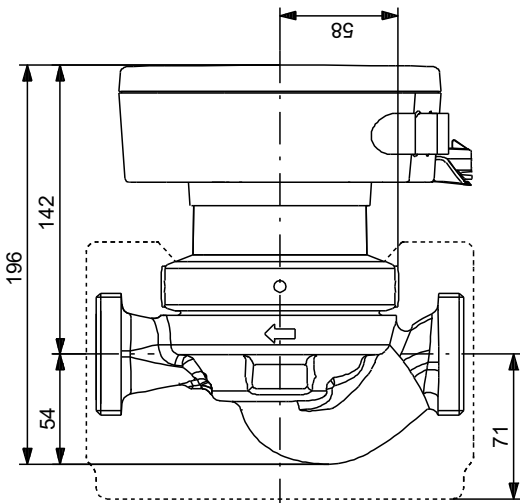
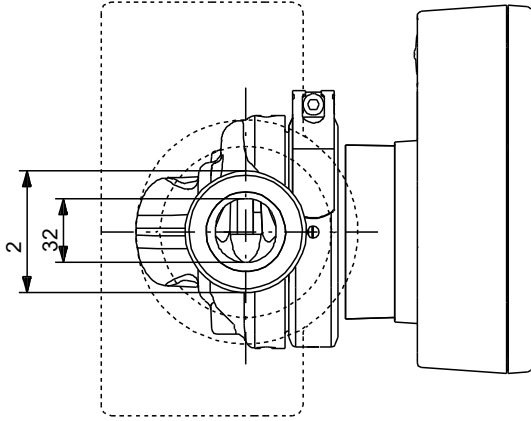

Note! All units are in [mm] unless others are stated.
Disclaimer: This simplified dimensional drawing does not show all details.

On request MAGNA1 32-60

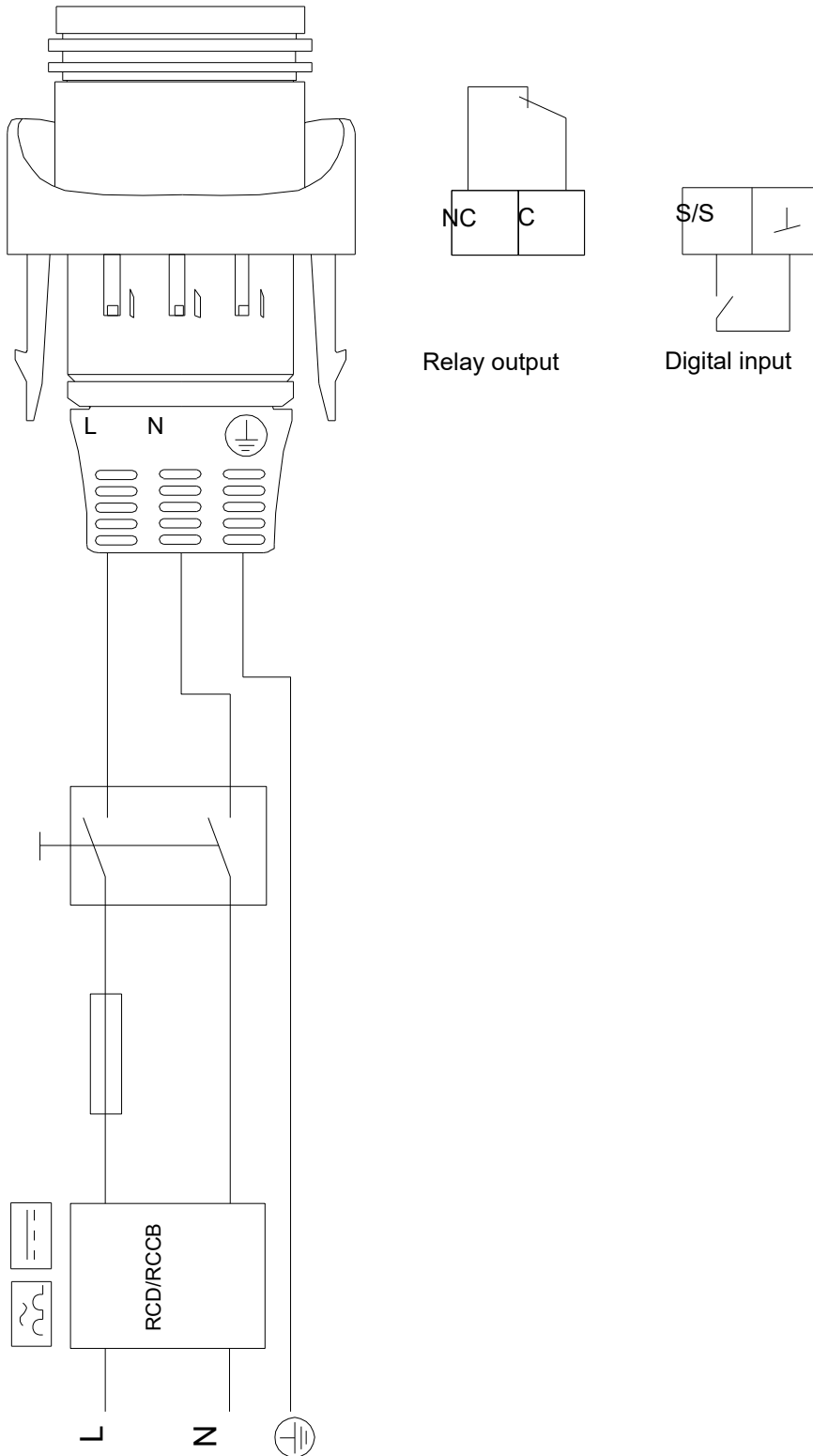

Note! All units are in [mm] unless others are stated.

(TM055854 MAGNA1 200W)

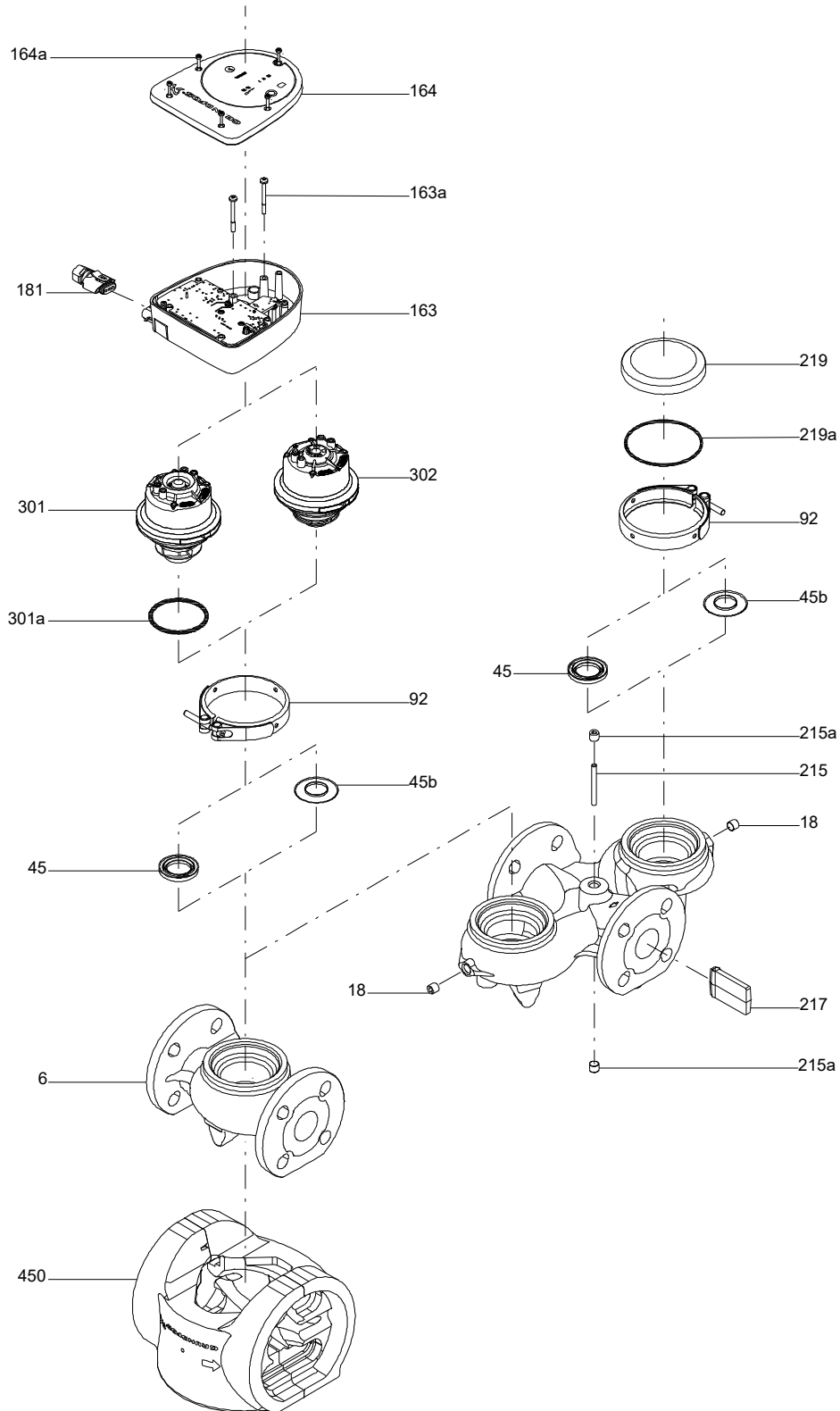

**Spare parts MAGNA1 32-60, Product No. On request
Produced After 1731 (production year and week number)**

Pos	Description	Annotation	Classification Data	Part no.	Qty.	Unit
-	Kit, Connector plugs			99461932	1	pcs
	Connector plug 2-pole				1	
	Connector plug				1	
181	Plug				1	
-	Kit, Control box configured			99487556	1	pcs
-	Kit,control box non-configured			99363376	1	
	Foil					
-	Control box cpl.					
	Controlboard Leaded					
	Spacer					
	Control box					
	Screw w/washer					
1.a	Screw DELTA PT					
163	Bottom					
164a	Screw DELTA PT					
164	Cover					
163a	Pan head screw					
	Conf.				1	
-	Kit, Cover			99364501	1	pcs
	Foil				1	
164	Cover				1	
-	Kit, Pump head			98357751	1	pcs
92	Clamp cpl.				1	
163a	Pan head screw				2	
302	Pump head				1	
-	Kit,control box non-configured			99363376	1	pcs
	Foil				1	
-	Control box cpl.				1	
	Controlboard Leaded					
	Spacer					
	Control box					
	Screw w/washer					
1.a	Screw DELTA PT					
163	Bottom					
164a	Screw DELTA PT					
164	Cover					
163a	Pan head screw				2	
-	Spare, Clamp			98148760	1	pcs
92	Clamp cpl.				1	
-	Spare, O-ring			98357755	1	pcs
301a	O-ring				1	
6	Pump housing			92500375	1	pcs
92	Clamp cpl.			98700283	1	pcs
164a	Screw DELTA PT			92708426	5	pcs
450	Insulation shell			98615808	1	pcs