

|                       |                  |             |
|-----------------------|------------------|-------------|
| PROJECT:              | UNIT TAG:        | QUANTITY:   |
| REPRESENTATIVE: _____ | TYPE OF SERVICE: | DATE: _____ |
| ENGINEER:             | SUBMITTED BY:    | DATE:       |
| CONTRACTOR:           | APPROVED BY:     | DATE:       |
|                       | ORDER NO.:       | DATE:       |

## MAGNA3 D 32-80



The MAGNA3 D circulator pump means double the performance and reduced downtime due to the three multipump modes: Alternating, backup and cascade operation. The two pumps communicate wirelessly. The MAGNA3 D is ideal for high-performance heating and cooling applications.

Note! Product picture may differ from actual product

| Conditions of Service |       | Pump Data                    |               | Motor Data        |            |
|-----------------------|-------|------------------------------|---------------|-------------------|------------|
| Liquid:               | Water | Maximum operating pressure:  | 10 bar        | P1 max:           | 9 .. 134 W |
| Temperature:          | 60 °C | Liquid temperature range:    | -10 .. 110 °C | Mains frequency:  | 50 / 60 Hz |
| Specific Gravity:     | 0.985 | Maximum ambient temperature: | 40 °C         | Enclosure class:  | X4D        |
|                       |       | Pipe connection:             | G 2"          | Insulation class: | F          |
|                       |       | Product number:              | On request    |                   |            |

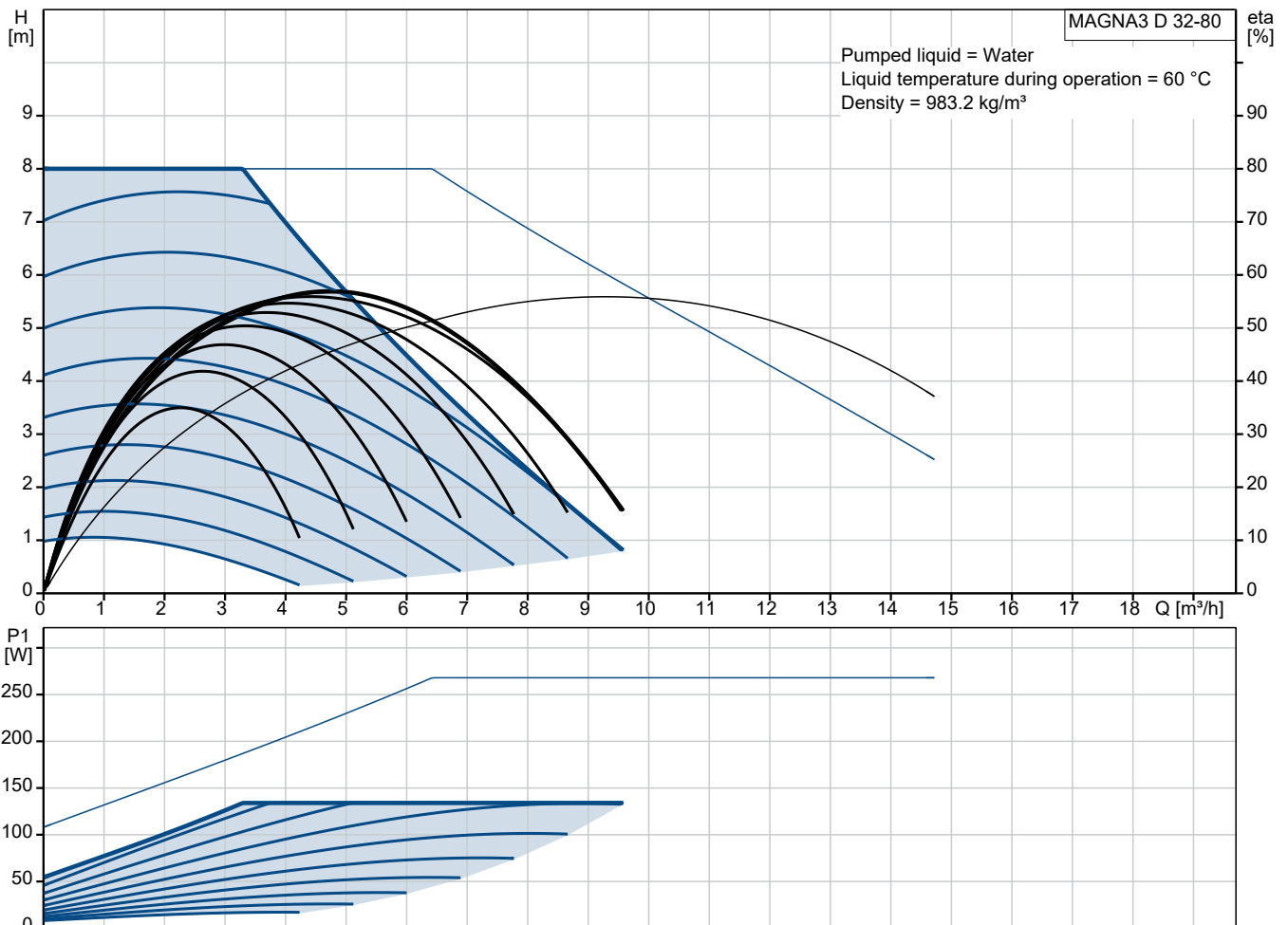

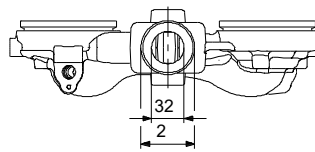
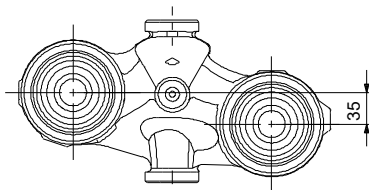
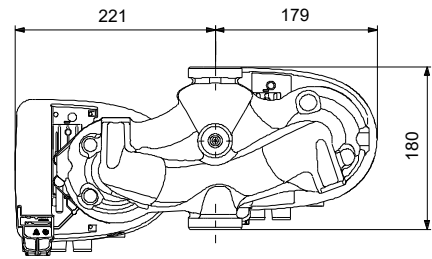
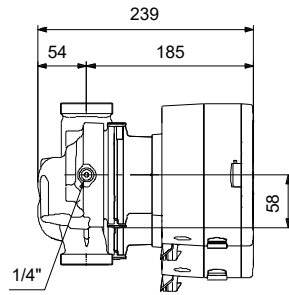
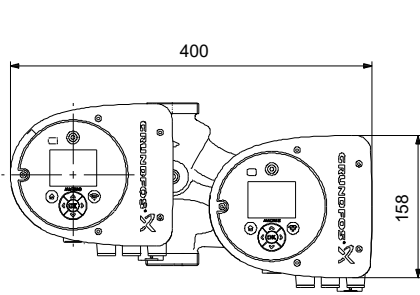

**Materials:**

- Pump housing: Cast iron
- Pump housing: EN-GJL-200
- Pump housing: ASTM A48-200B
- Impeller: PES 30%GF

Qty. Description

1 MAGNA3 D 32-80



Note! Product picture may differ from actual product

Product No.: On request

The Grundfos MAGNA3 D circulator pump is the ideal choice for almost any building project – old or new. With its unrivalled energy efficiency, all-encompassing range and built-in communication capabilities, MAGNA3 D is ideal for engineers and specifiers looking to create high-performance heating and cooling systems.

The pump is maintenance-free due to the canned-rotor type design. This also means that pump and motor form an integral unit without shaft seal and with only two gaskets for sealing. The bearings are lubricated by the pumped liquid.

MAGNA3 D offers three multipump modes: Alternating, backup and cascade operation.

In alternating and backup operation, only one pump operates at a time, both ensuring constant comfort.

In alternating operation, the change from one pump to the other depends on time or energy.

If a pump fails, the other pump will take over automatically.

In backup operation, the backup pump is operated at intervals to prevent seizing up.

If the duty pump stops due to a fault, the backup pump will start automatically.

In cascade operation, the pumps automatically switch on and off, adapting to the current consumption in the system.

The two pumps communicate wirelessly.

MAGNA3 D features an intuitive display and allows you to connect wirelessly with the Grundfos GO Remote app, giving you access to advanced reporting and monitoring.

MAGNA3 model E has Bluetooth, which allows you to connect directly to Grundfos Go app on your smart phone without any need for a dongle.

The pump includes fieldbus communication via CIM modules as well as analog and digital inputs and configurable relays.

Control features include AUTOADAPT and FLOWADAPT. FLOWADAPT which reduces the need for throttling valves, thus cutting costs on system components.

MAGNA3 D is the superior choice for a wide range of heating and cooling applications, including:

- Mixing loops
- Heating surfaces
- Air conditioning surfaces
- Ground-source heat pump systems
- Smaller chiller applications.

MAGNA3 D is a single-phase pump and characterised by having the controller and display integrated in the control box. The pump also has a built-in differential-pressure and temperature sensor.

The pump housing is available in both cast-iron and stainless-steel versions. The composite rotor can is carbon-fibre reinforced, the bearing plate and rotor cladding are made of stainless steel and the stator housing is made of aluminium. The power electronics are air-cooled.

MAGNA3 incorporates a 4-pole synchronous, permanent-magnet motor (PM motor). This motor type is characterised by higher efficiency than a conventional asynchronous squirrel-cage motor. The pump speed is controlled by an integrated frequency converter.

## On request MAGNA3 D 32-80

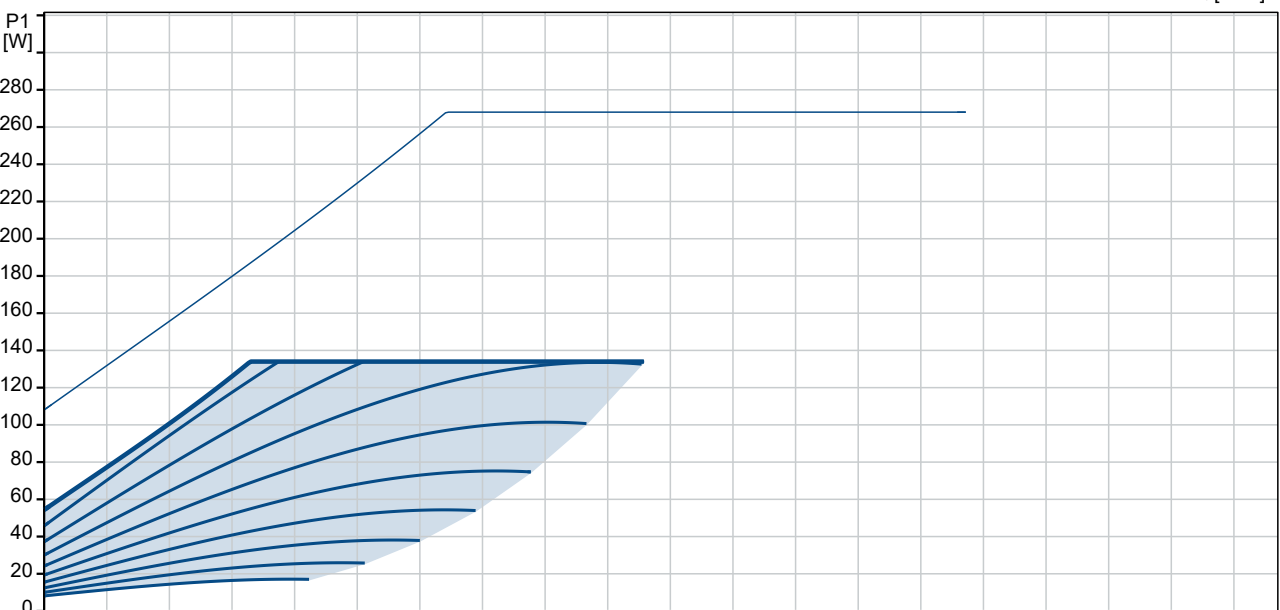
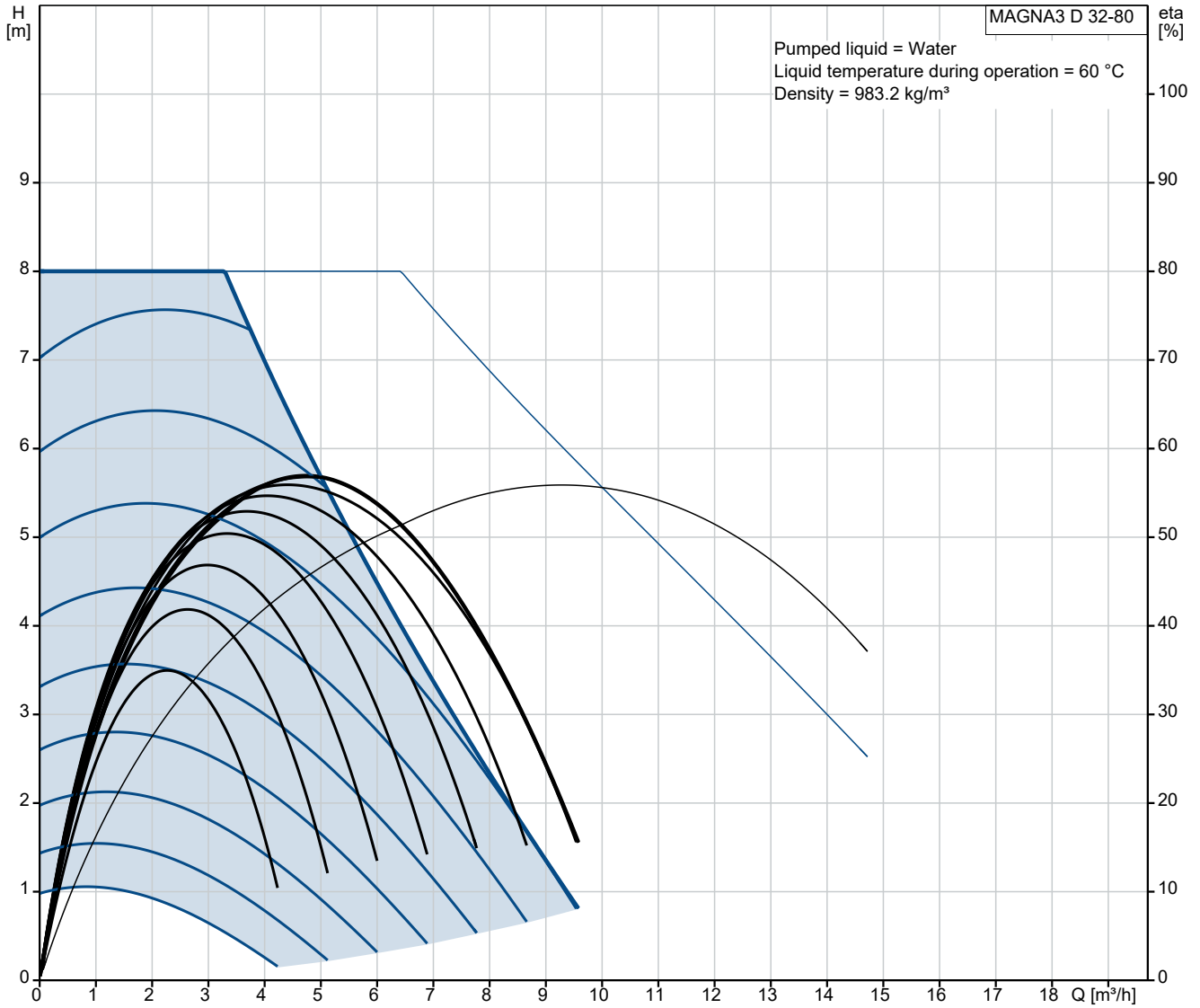

| Description                   | Value   |
|-------------------------------|---|
| <b>General information:</b>   |   |
| Product name:                 | MAGNA3 D 32-80                                |
| Product No:                   | On request                                    |
| EAN number:                   | On request                                    |
| <b>Technical:</b>             |   |
| Rated flow:                   | 4.77 m <sup>3</sup> /h                        |
| Rated head:                   | 5.966 m                                       |
| Head max:                     | 80 dm   |
| TF class:                     | 110   |
| Approvals:                    | CE, VDE, EAC, MOROCCO, UKCA, TSERCM, UkrSEPRO |
| Model:                        | E   |
| <b>Materials:</b>             |   |
| Pump housing:                 | Cast iron                                     |
| Pump housing:                 | EN-GJL-200                                    |
| Pump housing:                 | ASTM A48-200B                                 |
| Impeller:                     | PES 30%GF                                     |
| <b>Installation:</b>          |   |
| Range of ambient temperature: | 0 .. 40 °C                                    |
| Maximum operating pressure:   | 10 bar  |
| Pipe connection:              | G 2"  |
| Pressure rating:              | PN 10   |
| Port-to-port length:          | 180 mm  |
| <b>Liquid:</b>                |   |
| Pumped liquid:                | Water   |
| Liquid temperature range:     | -10 .. 110 °C                                 |
| Selected liquid temperature:  | 60 °C   |
| Density:                      | 983.2 kg/m <sup>3</sup>                       |
| <b>Electrical data:</b>       |   |
| Power input - P1:             | 9 .. 134 W                                    |
| Mains frequency:              | 50 / 60 Hz                                    |
| Rated voltage [V]:            | 1 x 230 V                                     |
| Maximum current consumption:  | 0.09 .. 1.19 A                                |
| Enclosure class (IEC 34-5):   | X4D   |
| Insulation class (IEC 85):    | F   |
| <b>Others:</b>                |   |
| Energy (EEI):                 | 0.18  |
| Net weight:                   | 13.2 kg                                       |
| Gross weight:                 | 14.6 kg                                       |
| Shipping volume:              | 0.055 m <sup>3</sup>                          |
| Norwegian NRF no.:            | 9042344                                       |
| Country of origin:            | DE  |
| Custom tariff no.:            | 84137030                                      |
| Environmental approvals:      | CN ROHS, WEEE                                 |

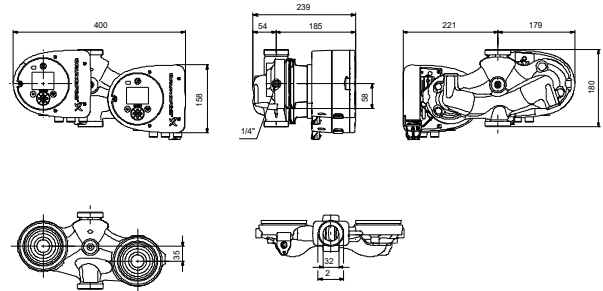
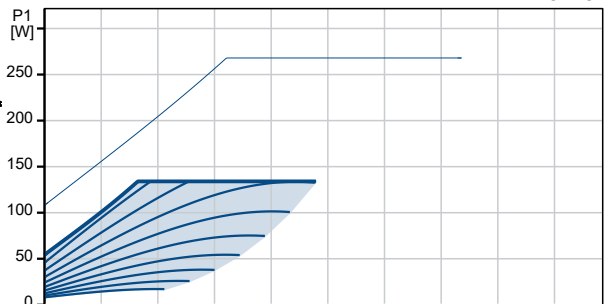
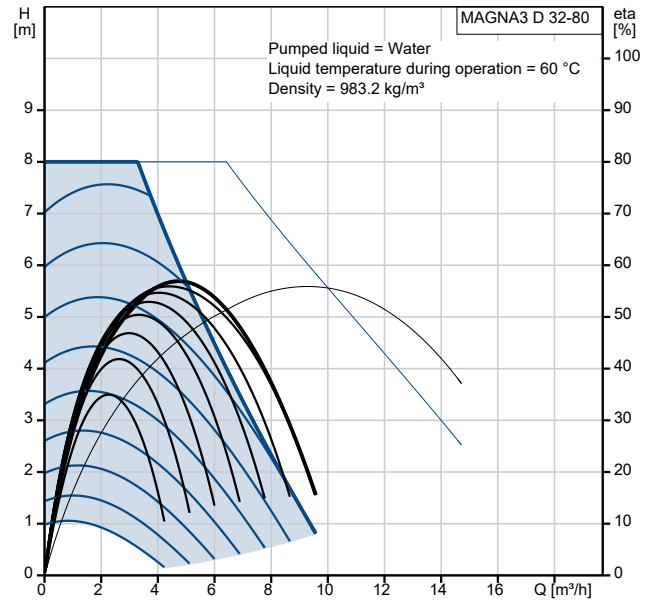

Example of mains-connected motor with mains switch, backup fuse and additional protection

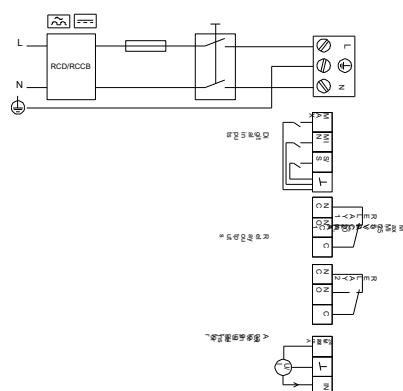

## On request MAGNA3 D 32-80

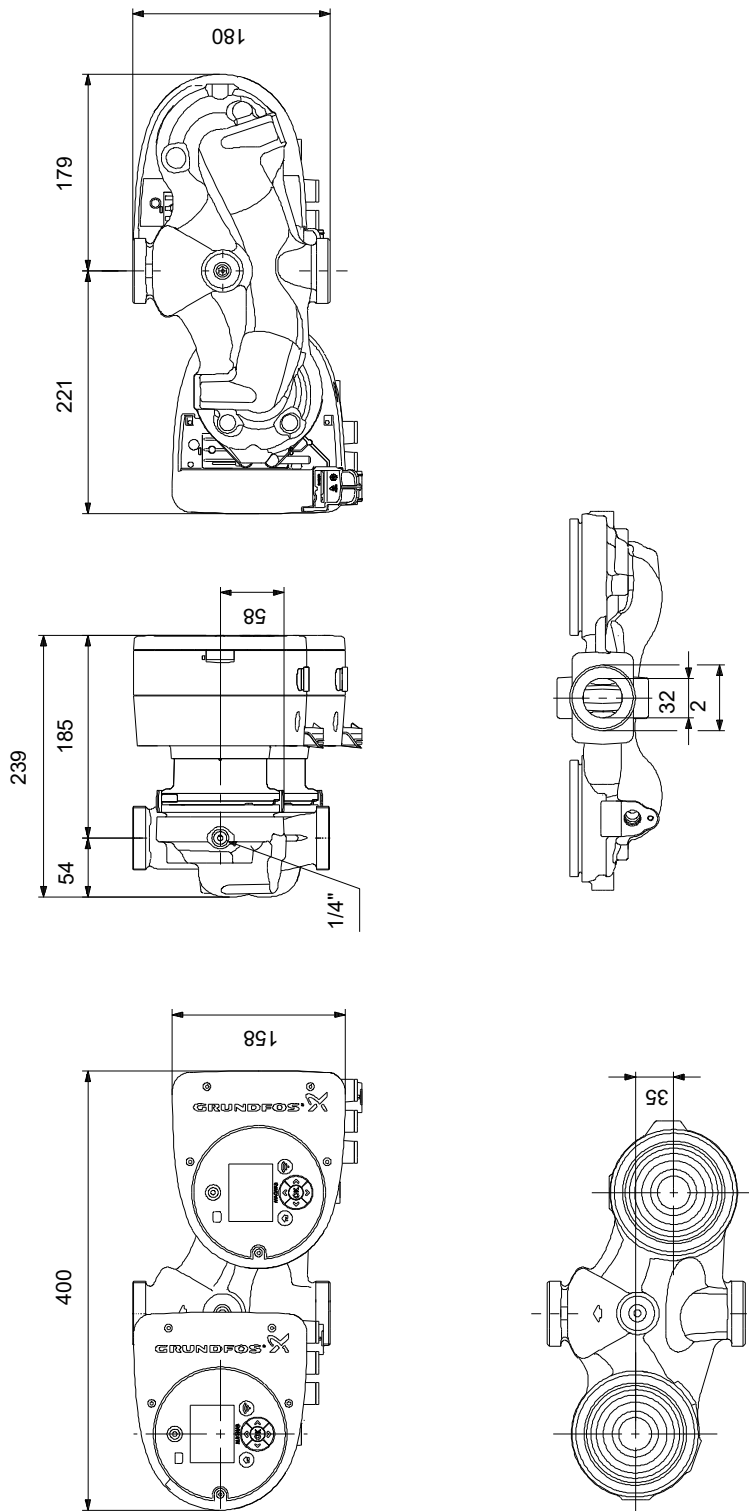

Note! All units are in [mm] unless others are stated.  
Disclaimer: This simplified dimensional drawing does not show all details.

## On request MAGNA3 D 32-80

Example of mains-connected motor with mains switch, backup fuse and additional protection

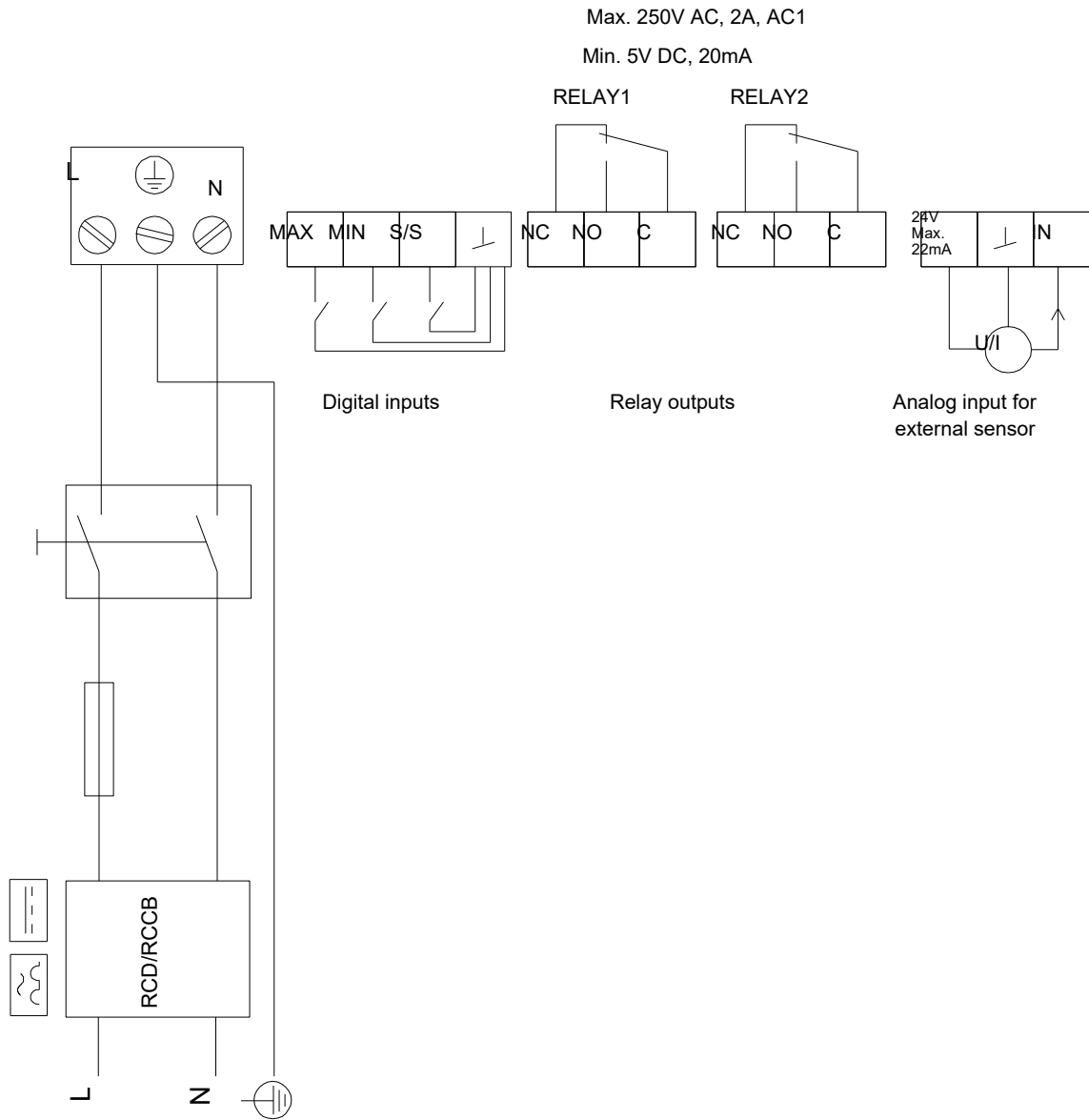

Note! All units are in [mm] unless others are stated.





( TM058038 Magna3 small)

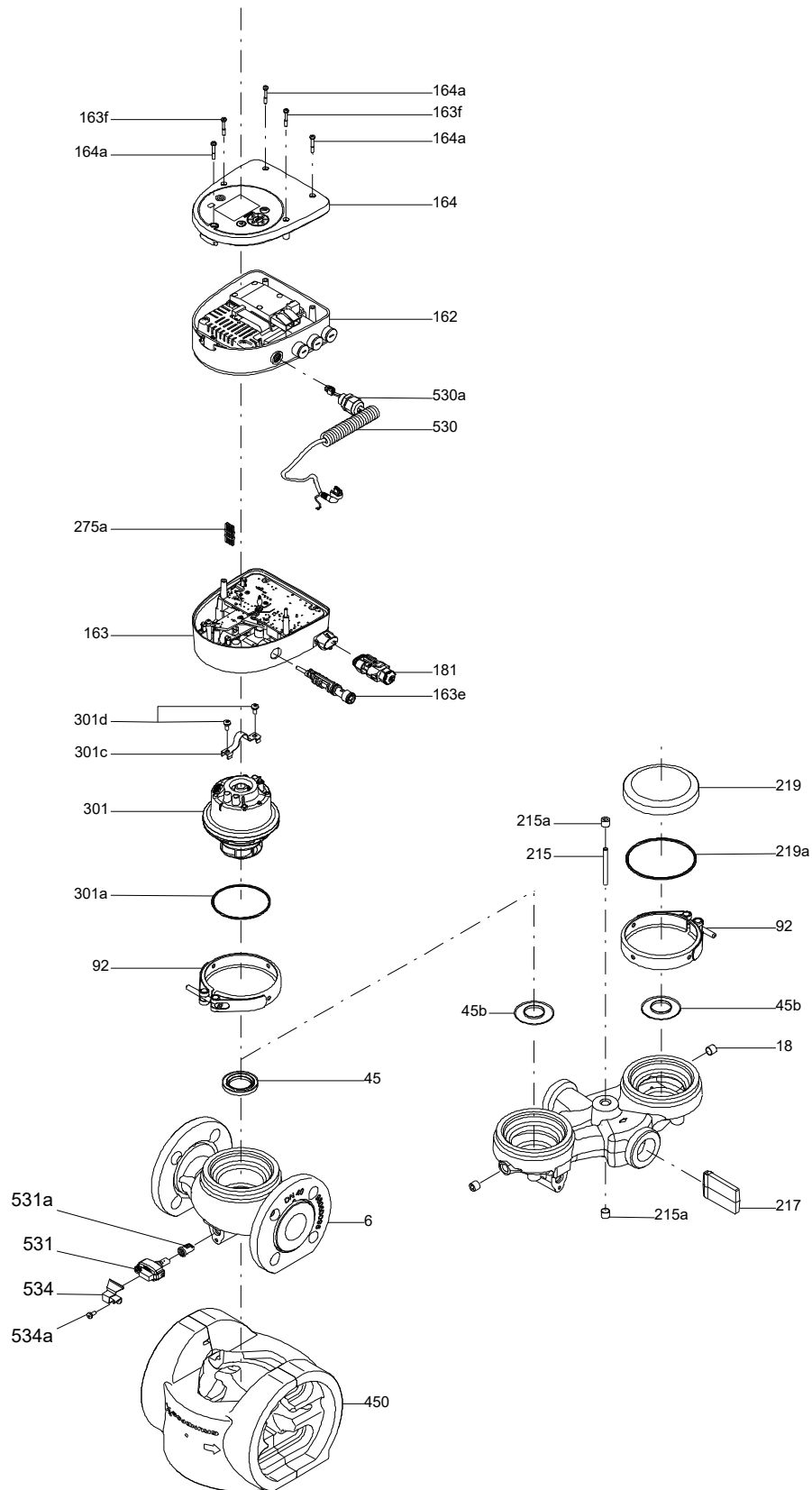

**Spare parts MAGNA3 D 32-80, Product No. On request  
Produced After 1732 (production year and week number)**

| Pos   | Description                    | Annotation | Classification Data | Part no. | Qty. | Unit |
|-------|--------------------------------|------------|---------------------|----------|------|------|
| -     | Kit, Control box conf. Head I  |            |                     | 99331678 | 1    | pcs  |
| -     | Kit,control box non-configured |            |                     | 98148726 | 1    |      |
| -     | Control box cpl.               |            |                     |          |      |      |
| -     | Bottom                         |            |                     |          |      |      |
| 163   | Box                            |            |                     |          |      |      |
| -     | Box                            |            |                     |          |      |      |
| 162   | Box                            |            |                     |          |      |      |
| 164   | Cover cpl.                     |            |                     |          |      |      |
| 530   | Cable                          |            |                     |          |      |      |
| - 531 | Sensor                         |            |                     |          |      |      |
| 531a  | Sealing cap                    |            |                     |          |      |      |
|       | Conf.                          |            |                     |          | 1    |      |
| -     | Kit, Control box conf. Head II |            |                     | 99332180 | 1    | pcs  |
| -     | Kit,control box non-configured |            |                     | 98148726 | 1    |      |
| -     | Control box cpl.               |            |                     |          |      |      |
| -     | Bottom                         |            |                     |          |      |      |
| 163   | Box                            |            |                     |          |      |      |
| -     | Box                            |            |                     |          |      |      |
| 162   | Box                            |            |                     |          |      |      |
| 164   | Cover cpl.                     |            |                     |          |      |      |
| 530   | Cable                          |            |                     |          |      |      |
| - 531 | Sensor                         |            |                     |          |      |      |
| 531a  | Sealing cap                    |            |                     |          |      |      |
|       | Conf.                          |            |                     |          | 1    |      |
| -     | Kit, Cover                     |            |                     | 99032834 | 1    | pcs  |
| 159a  | Cable w/plug                   |            |                     |          | 1    |      |
| 164a  | Screw DELTA PT                 |            |                     |          | 3    |      |
| 164a  | Screw DELTA PT                 |            |                     |          | 2    |      |
| 164   | Cover cpl.                     |            |                     |          | 1    |      |
| -     | Kit, Pump head                 |            |                     | 98419522 | 1    | pcs  |
| 92    | Clamp cpl.                     |            |                     |          | 1    |      |
| - 301 | Pump head                      |            |                     |          | 1    |      |
| -     | Stator w/housing cpl.          |            |                     |          |      |      |
| 301   | Stator housing                 |            |                     |          |      |      |
| 303   | Rotor can cpl.                 |            |                     |          |      |      |
| - 304 | Shaft w/impeller cpl.          |            |                     |          |      |      |
| -     | Bearing plate cpl.             |            |                     |          |      |      |
| 301a  | O-ring                         |            |                     |          |      |      |
| -     | Kit, Sensor                    |            |                     | 99313067 | 1    | pcs  |
| 530   | Cable                          |            |                     |          | 1    |      |
| - 531 | Sensor                         |            |                     |          | 1    |      |
| 531a  | Sealing cap                    |            |                     |          |      |      |
| 534a  | Pan head thread forming screw  |            |                     |          | 1    |      |
| 534   | Bracket                        |            |                     |          | 1    |      |
| -     | Kit, Sensor                    |            |                     | 99313072 | 1    | pcs  |
| 530   | Cable                          |            |                     |          | 10   |      |
| - 531 | Sensor                         |            |                     |          | 10   |      |
| 531a  | Sealing cap                    |            |                     |          |      |      |
| -     | Kit, Valve flap                |            |                     | 96407253 | 1    | pcs  |
| 215   | Guide pin                      |            |                     |          | 1    |      |
| 217   | Valve flap                     |            |                     |          | 1    |      |
| -     | Spare, Clamp                   |            |                     | 98148760 | 1    | pcs  |
| 92    | Clamp cpl.                     |            |                     |          | 1    |      |



Company name:

Created by:

Phone:

Date:

27/09/2022

| Pos  | Description        | Annotation | Classification Data | Part no. | Qty. | Unit |
|------|--------------------|------------|---------------------|----------|------|------|
| -    | Spare, O-ring      |            |                     | 98357755 | 1    | pcs  |
| 301a | O-ring             |            |                     |          | 1    |      |
| -    | Spare, Plug        |            |                     | 98284561 | 1    | pcs  |
| 181  | Plug               |            |                     |          | 1    |      |
| -    | Spare, Sealing cap |            |                     | 98613455 | 1    | pcs  |
| 531a | Sealing cap        |            |                     |          | 1    |      |
| 18   | Pipe plug          |            |                     | 96547615 | 2    | pcs  |
| 45b  | Neck ring          |            |                     | 99899633 | 2    | pcs  |
| 92   | Clamp cpl.         |            |                     | 98700283 | 2    | pcs  |
| 301a | O-ring             |            |                     | 92780125 | 1    | pcs  |
| 531a | Sealing cap        |            |                     | 98708139 | 1    | pcs  |